

PulseQ

AC Home **US Version**

TOPDON



AC EV Charger

User Manual

Contents

Abbreviations	3
Section 1—PRECAUTIONS	4
Section 2—STANDARDS COMPLIANCE	10
Section 3— PRODUCT OVERVIEW & INFO	12
Section 4—What's in the Box?	16
Section 5—Installation	17
Section 6—Network Configuration	29
Section 7—LED Indicators	38
Section 8—Fault Handling	39
Section 9—Warranty	40
Section 10—FCC	41

Abbreviations

S/N	Abbreviations	Description
1	IEC	International Electrotechnical Commission
2	EV	Electrical Vehicle, this can be BEV (battery EV) or PHEV (plug-in hybrid EV)
3	EVSE	Electric Vehicle Supply Equipment [IEC61851-1]
4	OBC	On-board charger (of an EV)
5	KW	Kilo Watt (unit of Power)
6	A	Ampere (unit of Current)
7	V	Volt (unit of Voltage)
8	Hz	Hertz (unit of Frequency)
9	LCD	Liquid Crystal Display
10	LED	Light-emitting Diode
11	CMS	Central Management System, manages EVSE and has the information for authorizing users for using its EVSE.
12	OCPP	Open Charge Point Protocol A standard open protocol for communication between EVSE and a Central System and is designed to accommodate any type of charging technique. (www.openchargealliance.org)
13	HMI	Human-Machine Interface
14	CCID	Charging Circuit Interrupting Device
15	GM/I	Ground Monitor Interrupter
16	GFCI	Ground Fault Circuit Interrupter

Section 1—PRECAUTIONS

1.1 IMPORTANT SAFETY PRECAUTIONS



WARNING- When using electric products, basic precautions should always be followed, including the following. This manual contains important instructions for Models and PULSEQ AC HOME that shall be followed during the installation, operation, and maintenance of the charging station.

1. Read all the instructions before using this product.
2. This device should be supervised when used around children.
3. Do not put fingers into the electric vehicle connector.
4. Do not use this product if the flexible power cord or EV cable is frayed, has broken insulation, or has any other signs of damage.
5. Do not use this product if the enclosure or the EV connector is broken, cracked, open, or shows any other indication of damage.
6. Note the ambient temperature rating: -22°F to 131°F (-30°C to 55°C)
7. **CAUTION:** To reduce the risk of fire, connect only to a circuit provided with 50 amperes maximum branch circuit overcurrent protection in accordance with the National Electrical Code, ANSI/NFPA 70, and the Canadian Electrical Code, Part I, C22.1.

Model	Current Rating
PulseQ AC Home	50 A

1.2 SAFETY NOTES

1.2.1 Safety signs used

The following warning signs, mandatory signs and information signs are used in this manual, on and in the AC EV Charger.



CAUTION: Warning of electrical hazards.

This sign is intended to alert the user that severe personal injury or substantial property damage can result if the device is not operated as requested.



ATTENTION: Warning of a dangerous spot or dangerous situation.

This sign is intended to alert the user that minor personal injury or material damage can result if the device is not operated as requested.



CAUTION: Do not touch in case of ESD.

Indicates possible consequences of touching electrostatically sensitive components.



No access for unauthorized persons.



Use protective footwear.



Must wear a safety helmet.



Indicates important texts, notes, or tips.

1.2.2 Safety Precautions for Installation



Safety protection must be worn when installing the EV Charger.



Installation must be performed carefully due to risk of electric shock.

Must be installed vertically to allow for ventilation. Do not install in areas of vibration or risk of impact.

Install in noncombustible areas due to risk of fire.

Do not drop any foreign objects, especially metal objects, inside the Charger due to risk of fire.

The lead nose of the Charger must be securely attached due to risk of damage.

1.2.3 Safety Precautions for Maintenance



Personnel must always use protective footwear when performing maintenance work.



It is recommended that Charger is routinely inspected at least once a week.

Do not put inflammable, explosive, or combustible materials, chemicals, combustible steam, or other dangerous goods near the Charger, due to risk of fire.



Keep the charging adapter clean and dry and wipe with a clean, dry cloth if soiled.

1.2.4 Safety Precautions for Maintenance



Strictly forbidden for minors or persons of restricted capacity to approach the Charger to avoid injury. Forced charging is strictly forbidden when the electric vehicle or Charger fails.



The electric vehicles can only be charged with the engine off and stationary. Do not charge in rainy and thunderous weather.

It is strictly prohibited to use the charger when the charging adapter or charging cables are defective, cracked, worn, broken or the charging cables is exposed. If you find any, please contact the supplier in time.

PRÉCAUTIONS

CONSIGNES DE SÉCURITÉ IMPORTANTES



AVERTISSEMENT- Lors de l'utilisation de produits électriques, des précautions de base doivent toujours être suivies, y compris les suivantes. Ce manuel contient des instructions importantes pour les modèles PULSEQ AC HOME qui doivent être suivies pendant l'installation, l'utilisation et la maintenance de l'unité.

1. Lisez toutes les instructions avant d'utiliser ce produit.
2. Cet appareil doit être surveillé lorsqu'il est utilisé à proximité d'enfants.
3. Ne mettez pas les doigts dans le connecteur du véhicule électrique.
4. N'utilisez pas ce produit si le cordon d'alimentation flexible ou le câble EV est effiloché, a une isolation cassée ou tout autre signe de dommage.
5. N'utilisez pas ce produit si le boîtier ou le connecteur EV est cassé, fissuré, ouvert ou montre toute autre indication de dommage.
6. Indiquez la température ambiante, de -30 ° C à 55 ° C.
7. **"MISE EN GARDE" et ce qui suit ou équivalent:** "Pour réduire le risque d'incendie, connectez uniquement à un circuit équipé d'une protection maximale contre les surintensités de circuit de dérivation de 50 ampères conformément au Code national de l'électricité, ANSI / NFPA 70 et au Code canadien de l'électricité, Partie I, C22.1.

Modèle	Note actuelle
PULSEQ AC HOME	50 A

NOTES DE SÉCURITÉ

1.2.1 Signes de sécurité utilisés

Les panneaux d'avertissement, panneaux obligatoires et panneaux d'information suivants sont utilisés dans le manuel d'utilisation, sur et dans la station de charge M3P EV:



MISE EN GARDE: Avertissement de risques électriques.

Ce signe est destiné à alerter l'utilisateur que des blessures graves ou des dommages matériels importants peuvent survenir si l'appareil n'est pas utilisé comme demandé.



ATTENTION: Avertissement d'un point de danger ou d'une situation dangereuse.

Ce signe est destiné à alerter l'utilisateur que des blessures légères ou des dommages matériels peuvent survenir si l'appareil n'est pas utilisé comme demandé.



MISE EN GARDE: En cas de décharge électrostatique, ne touchez pas à la main.

Indique les conséquences possibles du contact avec des composants sensibles à l'électricité statique.



Pas d'accès pour les personnes non autorisées.



Utilisez des chaussures de protection.



Doit porter un casque de sécurité.



Représente un texte, une note ou un indice important.

1.2.2 Précautions de sécurité pour l'installation



Une protection de sécurité doit être effectuée lors de l'installation de la station de charge EV.

L'installation doit être effectuée par du personnel qualifié, faute de quoi il y a un risque d'électrocution.

Il doit être installé à l'endroit sans vibrations et chocs violents, et placé verticalement pour faciliter la ventilation.



Il doit être installé sur des matériaux incombustibles, ou il existe un risque d'incendie.

Aucun objet étranger, en particulier un objet métallique, ne doit être placé dans le chargeur sans risque d'incendie.

Les fils du chargeur doivent être solidement connectés, faute de quoi le matériel risque d'être endommagé.

1.2.3 Précautions de sécurité pour l'entretien



Le personnel doit toujours porter des chaussures de protection lors des travaux de maintenance.



Il est recommandé que le chargeur fasse l'objet d'un contrôle de sécurité au moins une fois par semaine.

Il est interdit de placer des substances dangereuses telles que des matières inflammables, explosives ou inflammables, des produits chimiques, des vapeurs inflammables à proximité des chargeurs, faute de quoi il y a un risque d'incendie.



Maintenir l'adaptateur de charge propre et sec, en cas de saleté, et l'essuyer avec une toile sèche propre. Ne touchez pas le chargeur avec la main.

1.2.4 Précautions de sécurité pour l'entretien



Il est strictement interdit aux mineurs ou aux personnes dont la capacité de mouvement est limitée d'avoir accès au chargeur pour éviter les blessures.

La charge forcée est interdite en cas de panne du véhicule électrique ou du chargeur.



Le véhicule électrique ne peut être rechargé que si le moteur est éteint et statique. Il ne faut pas recharger les jours de pluie et les orages.

L'utilisation de chargeur est strictement interdite lorsque l'adaptateur de charge ou le câble de charge présente des défauts, des défauts, des défauts, de l'usure, de la rupture ou de la nudité. En cas de découverte, veuillez contacter le fournisseur en temps voulu.

Section 2—STANDARDS COMPLIANCE

2.1 Standard(s) for safety

Conformes to UL 2594, 2nd, Ed., Issue Date: 2016-12-21

2.2 AC Level 2 Charging

According to SAE J 1772, PulseQ AC Home product (the maximum output current is 40 A) was designed for AC Level 2 charging.

2.3 Charging mode and connection

According to IEC 61851-1, the Charging mode of PulseQ AC Home is Mode 3, and charging connection is the Case C.

Mode 3

a method for the connection of an EV to an AC EV supply equipment permanently connected to an AC supply network, with a control pilot function that extends from the AC EV supply equipment to the EV.



Case C:

Connection of an EV to a supply network utilizing a cable and vehicle connector permanently attached to the EV charger.

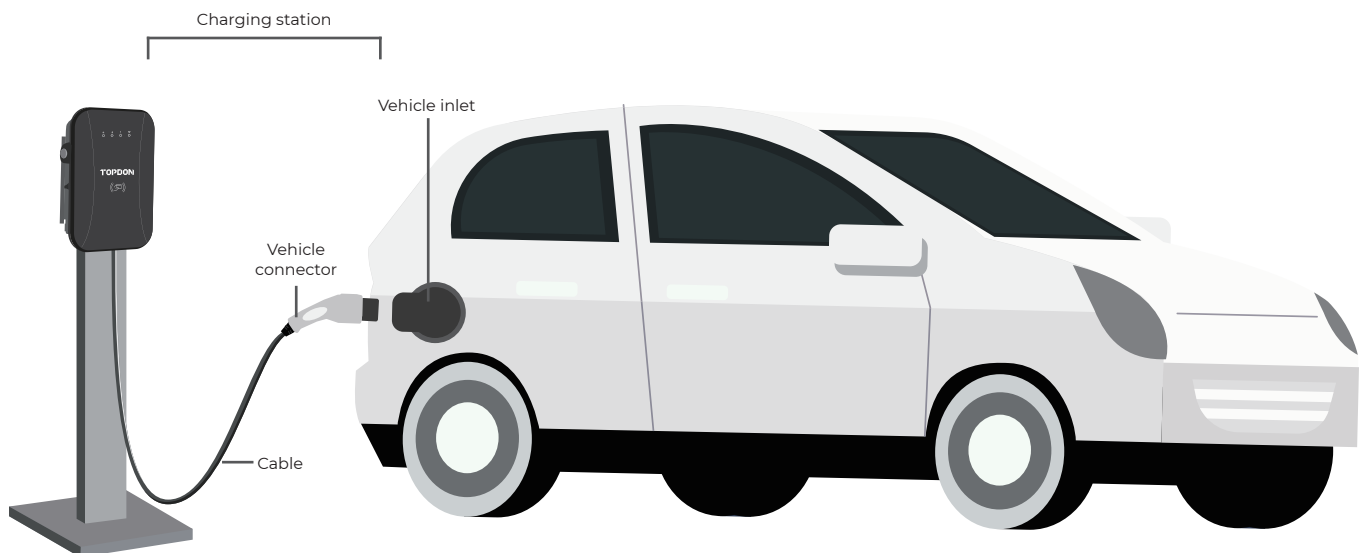

2.4 Charging interface

The charging plug of PulseQ AC Home product meets SAE J1772/IEC 62196-2, Type 1.

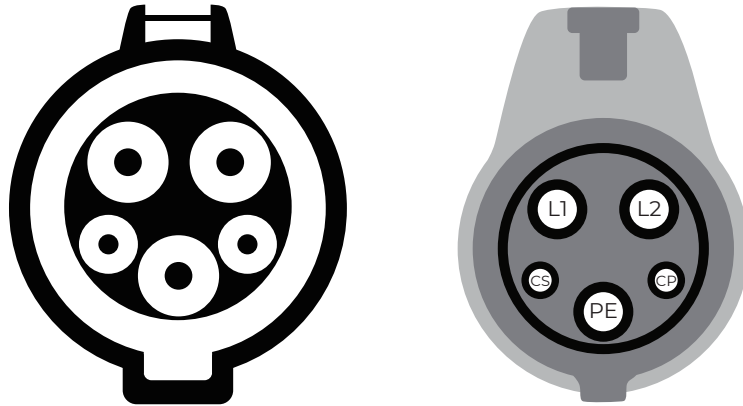

Fig. 2.4.1 Schematic diagram of Type 1 interface

PulseQ AC Home provides a Type 1 female plug with charging cable, it only charges an EV with a Type 1 charging socket (vehicle inlet).

Section 3—PRODUCT OVERVIEW & INFO

3.1 Shape & Dimensions

The shape & dimensions of PulseQ AC Home charger are shown as Fig. 3.1.1

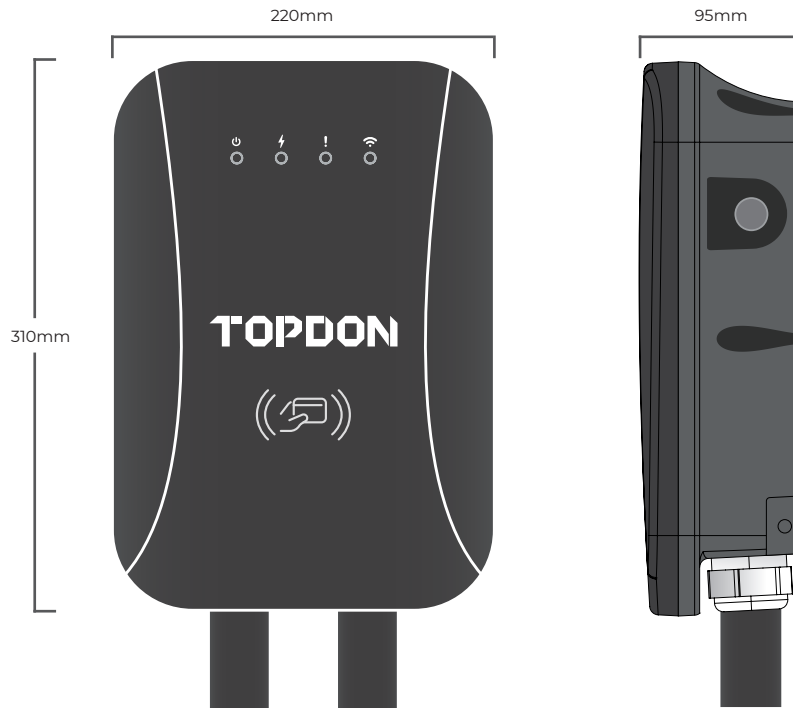

Fig. 3.1.1 The shape & dimensions of PulseQ AC Home

3.2 Block diagram

The block diagram of PulseQ AC Home charger is shown as Fig. 3.2.1

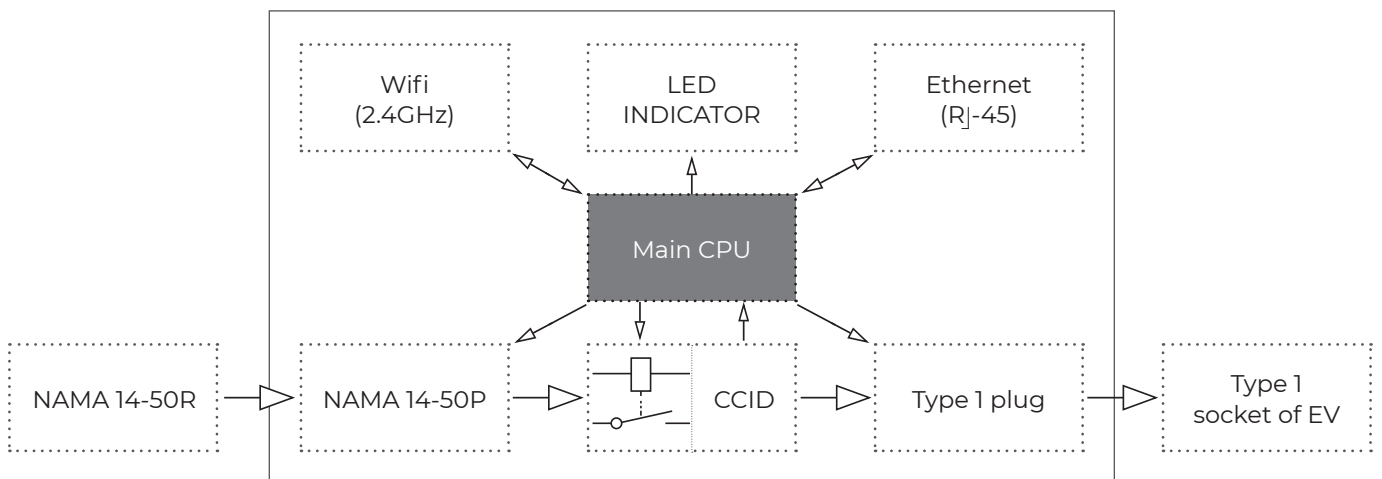
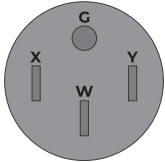

Fig. 3.2.1 Block Diagram

It is widely used in various household electric vehicle charging in North America, as well as various chargers, parking lots, community garages and public electric vehicle charging places.

3.3 Specifications

3.3.1 Electrical Specifications

Model Number	PULSEQ AC HOME	
Rated Voltage	240V/208V (AC Level 2 Charging), 50/60Hz	
Rated Current	40A	
Rated Power	9.6kW (@240VAC)	
Input plug & cable	Plug: NEMA 14-50P; Cable: 4×8 AWG, 300mm, copper.	
		X: L1;
		Y: L2;
		W: No connect terminal;
G: Ground.		
Charging interface	IEC 62196-2, Type 1 plug with 5m cable、 IEC 62196-2, Type 1 plug with 7.5m cable	
	Note: Extension cords are not be used.	

3.3.2 Functional Description

Charging Mode	Mode 3
Charging Control	Remote: APP-controlled
	Local: Plug and charge
Indicator Lights	4 LED lights;
	Indicate 4 statuses including standby, charging, fault, and network
Communication interface	WiFi (2.4GHz), Ethernet (RJ-45 interface).
	And support OCPP 1.6J Protocol (Optional)
Communication interface (Optional)	RS-485 with special communication protocol
Safety Protection	Surge protection, over temperature, over/under voltage, over current, ground protection
CCID built-in	CCID 20

3.3.3 Mechanical Parameters

Mounting	Wall-mounted
Net Weight	≤ 7KG (5m cable) 、 ≤ 9KG (7.5m cable)
Dimension	H×W×D = 310mm × 220mm × 95mm
Color & Material	Front cover: Gray, PC; Back cover: Black, PC
Enclosure rated	Type 4

3.3.4 Ambient Conditions

Altitude	≤ 2000m
Storage temperature	-40°F to 167°F (-40°C to 75°C)
Operation temperature	-22°F to 131°F (-30°C to 55°C)
Relative humidity	≤ 95%RH, no water droplet condensation
Vibration	< 0.5G, no acute vibration and impactation
Installation location	Indoor or outdoor, good ventilation, no flammable or explosive gases

3.3.5 Nameplate

WARNING

- ▷ For use with electric vehicles.
- ▷ Pour utilisation avec des véhicules électriques.
- ▷ To avoid a risk of fire or electric shock, do not use this device with an extension cord.
- ▷ Pour réduire le risque de choc électrique ou d'incendie, ne pas utiliser de rallonge avec cet appareil.
- ▷ Risk of explosion. This equipment has arcing or sparking parts that should not be exposed to flammable vapors. This equipment should be located at least 460 mm (18 inches) above the floor.
- ▷ Risque d'explosion. L'appareil comporte des pièces pouvant produire des arcs électriques ou des étincelles qui ne devraient pas être exposées aux vapeurs inflammables. Cet appareil devrait être installé à au moins 460 mm (18 pouces) au-dessus du plancher.
- ▷ Risk of explosion. This equipment has internal arcing or sparking parts which should not be exposed to flammable vapors. It should not be located in a recessed area or below floor level.
- ▷ Risque d'explosion. L'appareil comporte des pièces internes pouvant produire des arcs électriques ou des étincelles qui ne devraient pas être exposées aux vapeurs inflammables. Cet appareil ne devrait pas être encastré ni installé sous le niveau du sol.
- ▷ This device is intended only for charging vehicles not requiring ventilation during charging.
- ▷ Ce dispositif est destiné au chargement des véhicules ne nécessitant pas de ventilation au cours du chargement.

▲ NOTE

- ▷ Read owners manual before use.
- ▷ Veuillez lire le manuel de l'utilisateur avant utilisation.
- ▷ Ventilation not required.
- ▷ Aucune ventilation requise.
- ▷ The suitability of the use of flexible cord in accordance with CE code, Part I, Rule 4-012, is to be determined by the local inspection authority having jurisdiction.
- ▷ C'est à l'autorité locale compétente en matière d'inspection qu'incombe de déterminer si un cordon souple peut être utilisé conformément à l'article 4-012 du ccé, première partie.

▲ CAUTION

- ▷ To reduce the risk of electric shock, connect only to properly grounded outlets.
- ▷ Pour réduire le risque de choc électrique, brancher sur une prise correctement mise à la terre.
- ▷ Do not use this product if there is any damage to the unit.
- ▷ Ne pas utiliser ce produit si l'appareil est endommagé.
- ▷ Risk of electric shock. Do not remove cover or attempt to open the enclosure. No user serviceable parts inside. Refer servicing to qualified service personnel.
- ▷ Risque de choc électrique. Ne pas retirer le couvercle ni essayer d'ouvrir le boîtier. Aucune pièce interne réparable par l'utilisateur. Confier tout travail d'entretien ou de réparation à un technicien qualifié.

Model No.: PulseQ AC Home
Input Phase: L1 + L2 + GND
Rated Input: 240VAC, 60Hz, Max. 40A(@55°C)
Rated Output: 240VAC, 60Hz, Max. 40A(@55°C)
Electrical Enclosure: Type 4
Temperature Rating: 22°F to 131°F (-30°C to 55°C)
GFI circuit breaking features inside.

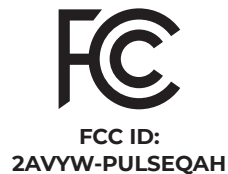

Section 4—What's in the Box?

a. AC EV Charger (14-50P input power cable & 5/7.5m charging cable)	1
b. Charging Dock	1
c. Wall-mounting Accessories	1
d. User Manual	1
e. Quick User Guide	1
f. Quality Certificate	1
g. Wall Installation Template	1
h. M6×63mm Expansion Bolt	4
i. M5×40mm Expansion Bolt	4
j. Charging Dock Installation Template	1
k. IC card	2

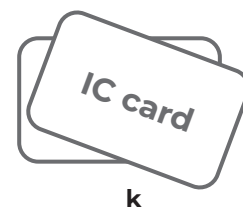
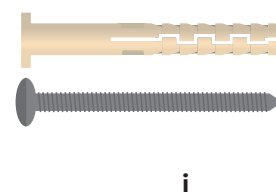
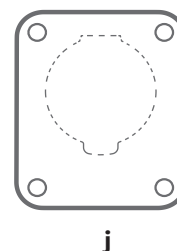
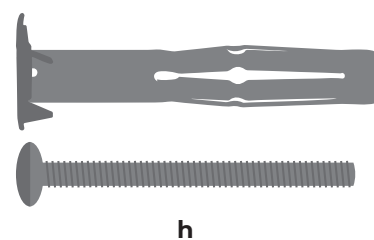
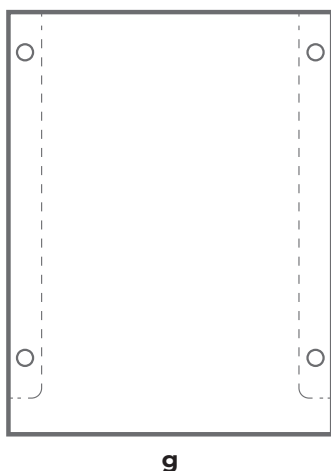
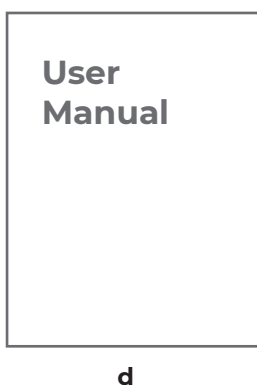
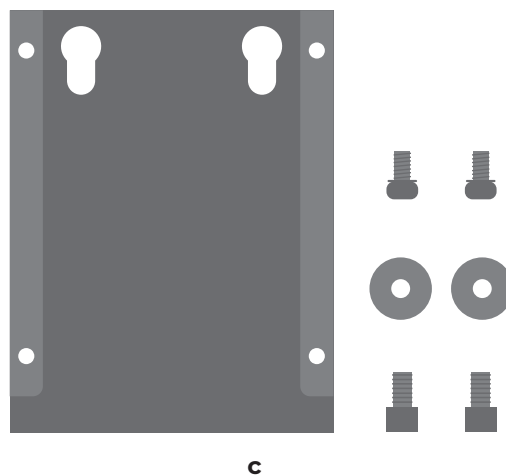
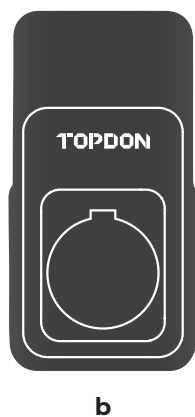
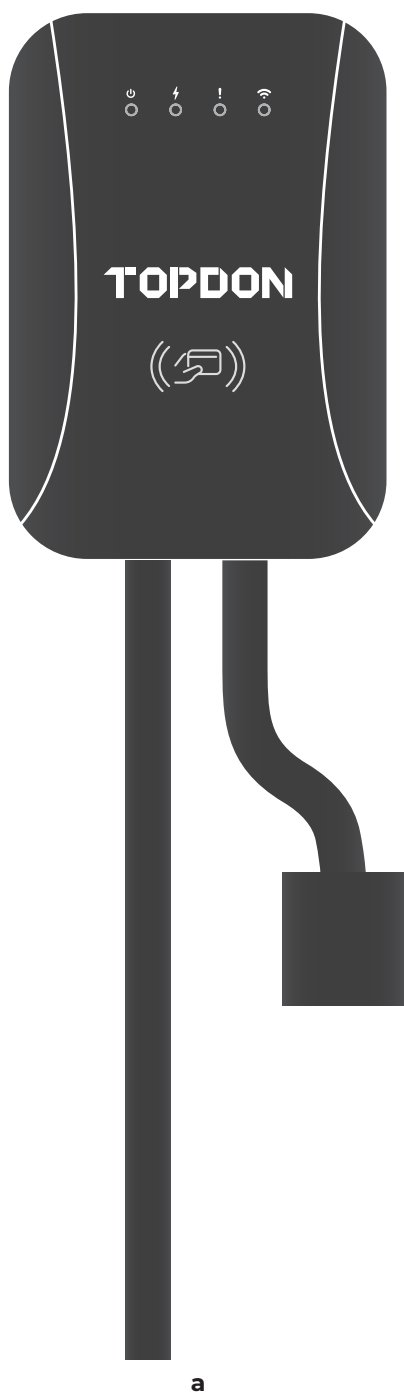

Section 5—Installation

5.1 Pre-Installation Inspection

When unpacking, please carefully confirm the following points:

- Whether the accessories are missing according to the packing list.
- Whether there is any damage during transportation.
- Whether the model and specification of the machine's nameplate are consistent with the order requirements.



▷ If any damage or missing parts are found, please do not start the installation, and contact us as soon as possible.



▷ Please keep the packing box and packing materials for 1 month for future handling.
▷ The paper packaging is recyclable.

5.2 Pre-work Preparation

- When transporting or moving the EV charger, pay attention to the following points to ensure product safety:



▷ This product is electrical equipment. It should be handled with care, avoiding violent vibration and impact.

▷ The charger shall not be transported by dragging the charging connector and the charging cable.

- In order to ensure the long-term stable operation of the product, it is recommended to avoid installing chargers in extreme weather, especially as low or high ambient temperatures may affect the installation effect due to thermal expansion and cold contraction.
- The electrical power supply socket (NEMA 14-50R) must be prepared.
- Space requirement: When the charger is fixed on the wall, the minimum space requirements are shown in Fig. 5.2. (Only for hardwired installation)
- It is suggested that the charger should be installed in a place with good ventilation, no direct sunlight and shelter from wind and rain. In order to ensure good ventilation, mount the charger vertically with clear space around all sides.

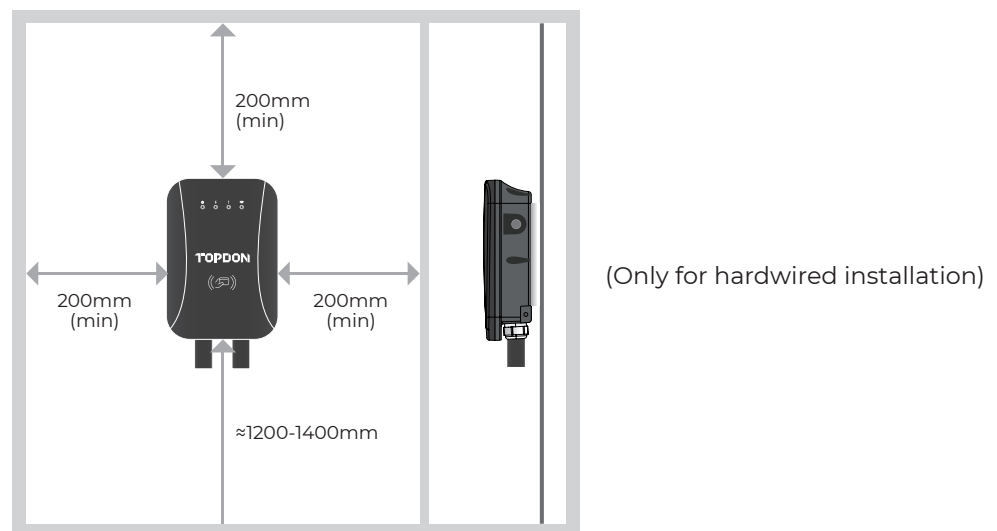
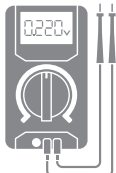
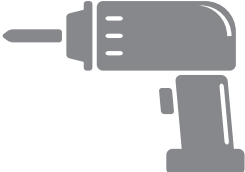

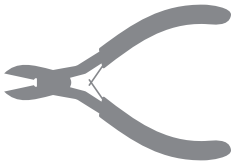
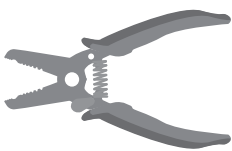
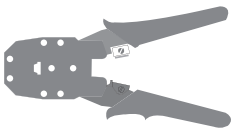

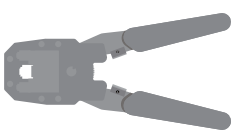

Fig. 5.2 Minimum space requirements for wall mounting

5.3 Tools for Installation

Please prepare the following tools before installation

No.	Tools' Name	Schematic Picture	Main Uses
1	Multimeter		Check the electrical connection and measure the voltage
2	Electric Impact drill		Drill fixing holes in the wall
3	Wrench		Fastening bolt
4	Diagonal plier		Cut the cable
5	Wire stripper		Peeling cables
6	Crimping plier		Pressed cable terminal
7	Phillips screwdriver		Fastening screw
8	RJ45 Crimper		Crimp the RJ45 connector

5.4 Wall Bracket Installation

1. Ensure the homeowner has chosen an installation location that allows the charging cable to reach the car's charging port while still providing slack. Ensure there is a stud available at the desired location for mounting the charging station. (See Fig. 5.4.1) Ensure there is WiFi signal available.



Fig. 5.4.1



WARNING: In areas with frequent thunderstorms, add surge protection at the service panel for all circuits. Ensure all power and ground connections, especially those at the breaker and bus bar, are clean and tight. Remove all oxide from all conductors and terminals before connecting wiring.

2. For plug-in installation, the NEMA outlet should be located 500-660 mm (20-26 in) from the ground adjacent to the stud where the charging station will be mounted. (See Fig. 5.4.2)

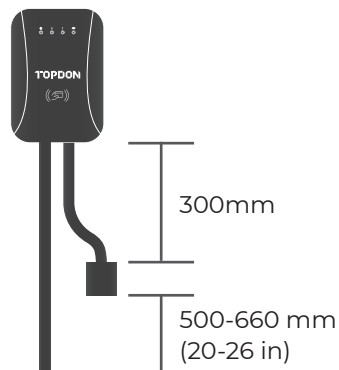

Fig. 5.4.2

1. Refer to the Fig. 5.4.3 to understand the dimensions of the wall bracket. Please make sure the space on the wall is at least 5.62" x 5.98" (143mm x 152mm).

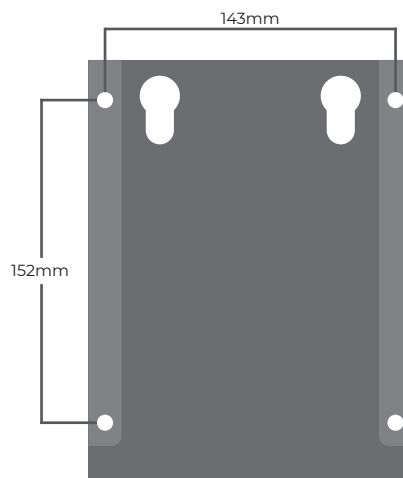

Fig. 5.4.3

2. Mark the mounting hole on the wall with the installation template. (See Fig. 5.4.4)

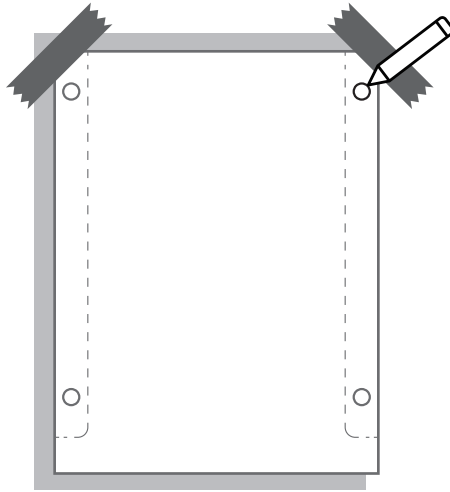

Fig. 5.4.4

3. Drill the mounting holes on the wall with a depth of at least 1.97". (See Fig. 5.4.5)

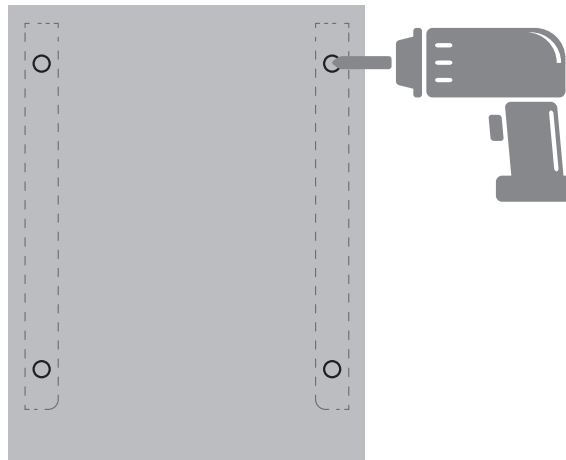

Fig. 5.4.5

3. Hammer the expansion sleeve into the corresponding hole (See Fig. 5.4.6)

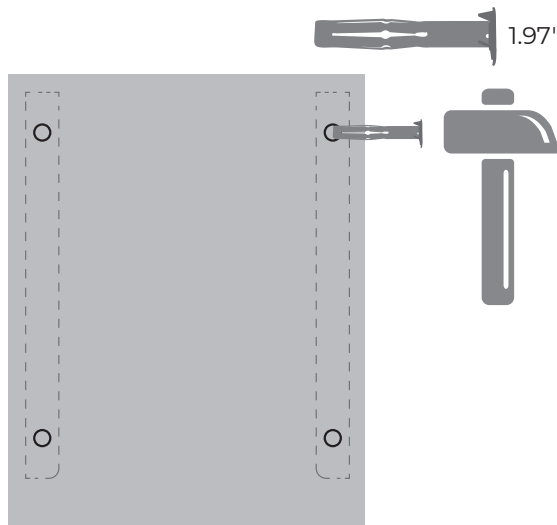

Fig. 5.4.6

5. Fix the bracket to the wall with the expansion screws (See Fig. 5.4.7) included in the package.

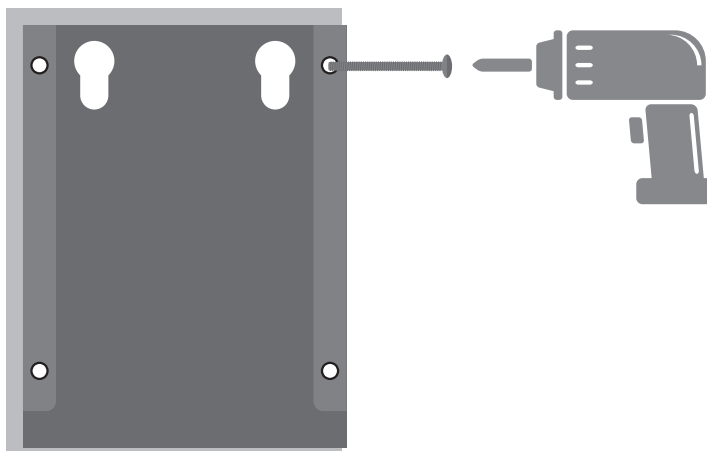

Fig. 5.4.7

5.5 Plug-in Installation



- ▷ For plug-in installation, confirm that the wall bracket has been fixed on the wall.
- ▷ Consult an electrician for any NEMA 14-50 installation questions.

1. Determine the plug type purchased by the homeowner. The NEMA 14-50 is required. (See Fig. 5.5.1)
2. Hang the charging station to the wall bracket and fasten the bolts on the each side. (See Fig. 5.5.2)
3. Plug in the charging cable and start the initial charge.

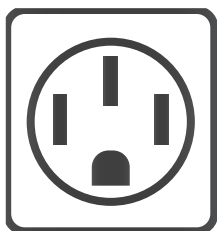

Fig. 5.5.1

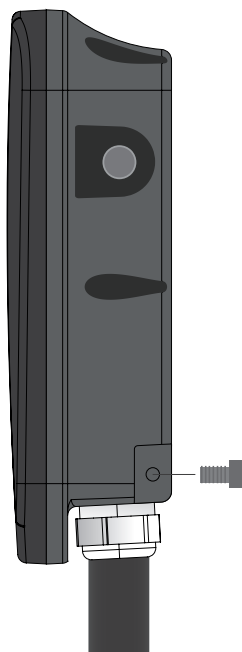

Fig. 5.5.2

5.6 Hardwire Installation



▷ The hardwire installation needs to be done by electricians, and please strictly follow the safety precautions.

1. Remove the four screws on the back cover with a Phillips screwdriver. (See Fig. 5.6.1)

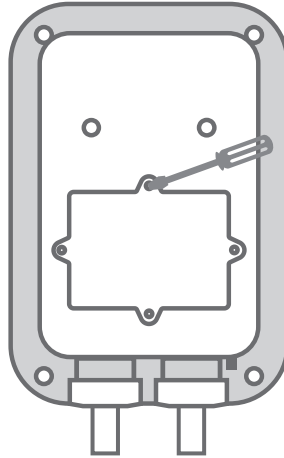

Fig. 5.6.1

2. Remove the three screws with flat-blade screwdriver and take off the cable wire from the terminal block. (See Fig. 5.6.2)

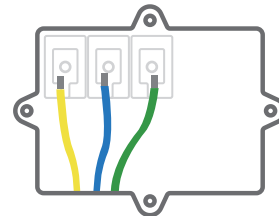
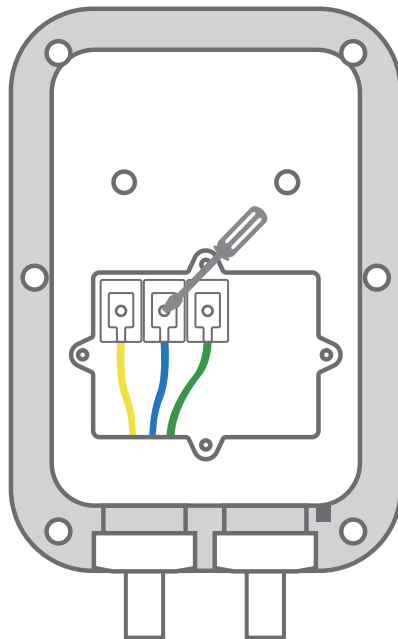

Fig. 5.6.2

3. Unscrew the bolts at the bottom of the charging station (See Fig. 5.6.3). You can use a large wrench if needed.

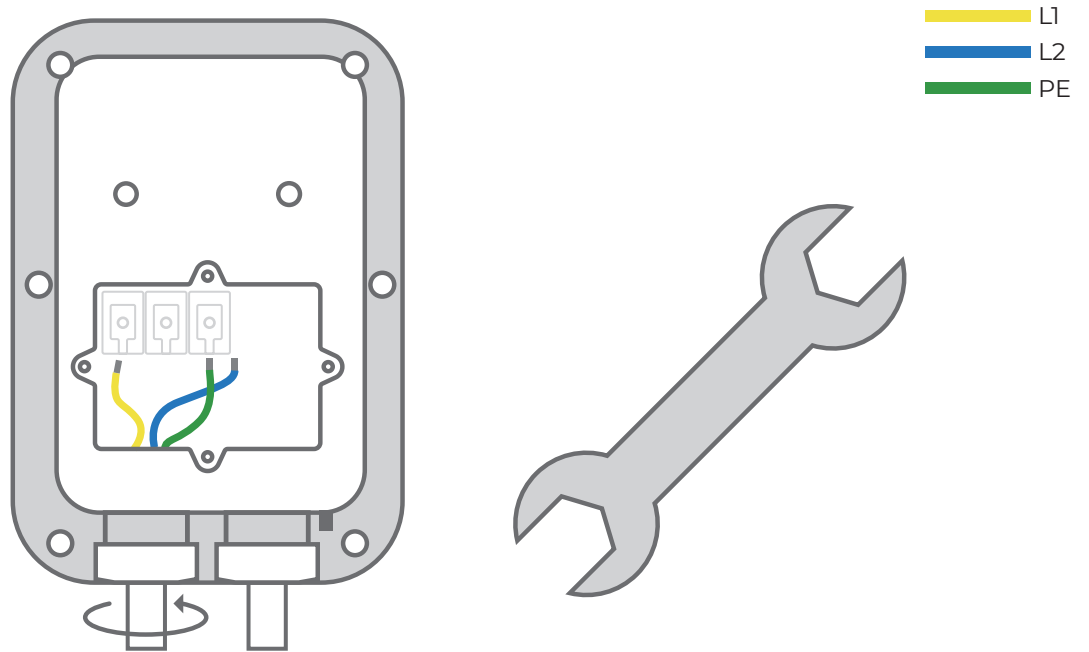

Fig. 5.6.3

4. Take out the cable wire, and remove the magnet ring. (See Fig. 5.6.4)

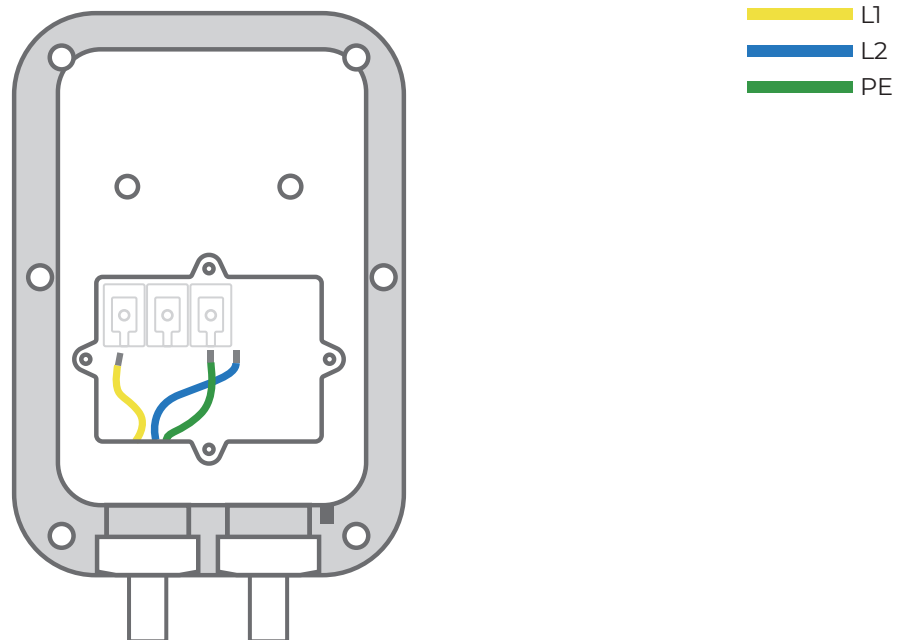

Fig. 5.6.4

5. Unscrew all six screws with the Phillips screwdriver, and take the back cover off. (See Fig. 5.6.5)
There is another bolt hidden underneath the UL certification label. Please remove the lable to unscrew the bolt.

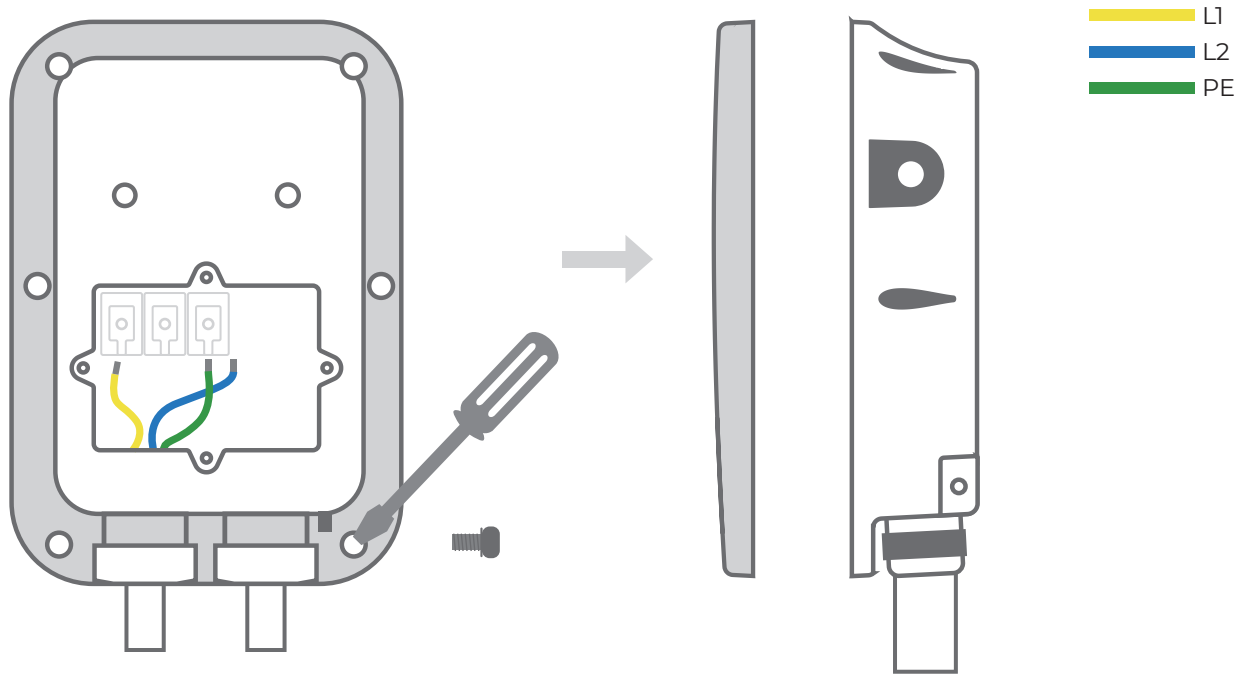

Fig. 5.6.5

6. Unscrew the cable clip, and take out the cable from the bottom hole. (See Fig. 5.6.6)

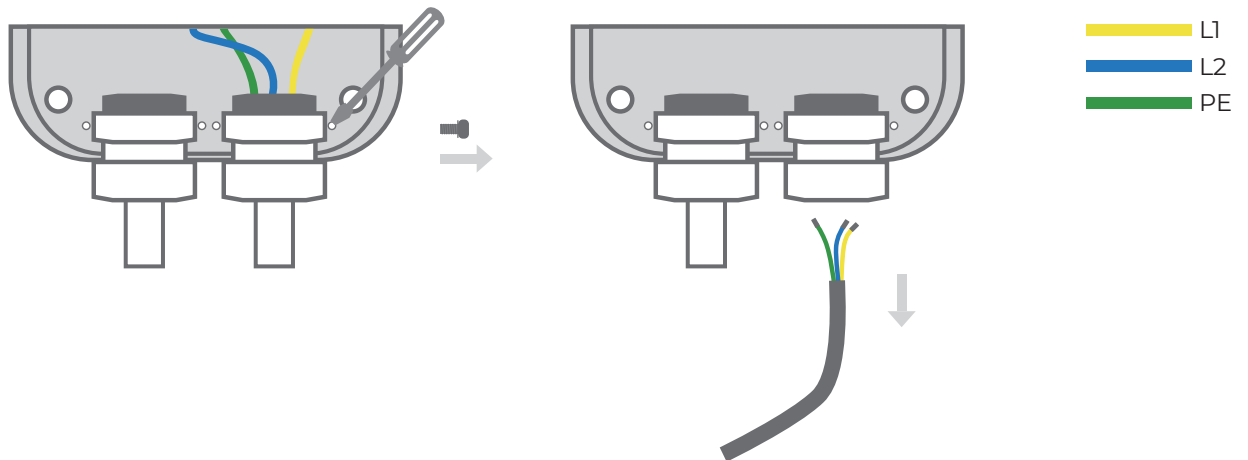

Fig. 5.6.6

7. Crimp the service wiring with the crimping plier (See Fig.5.6.7)

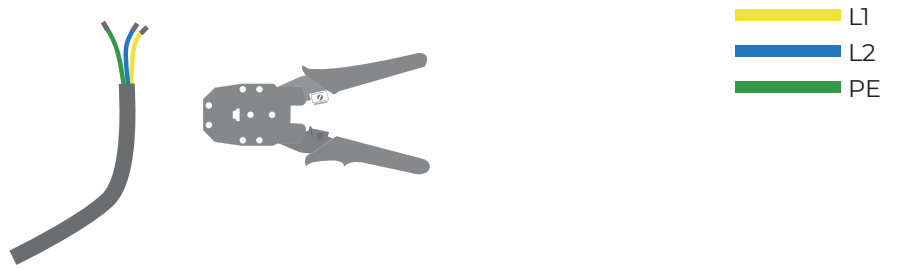

Fig. 5.6.7

8. Pass through the service wiring from the right bottom hole. (See Fig. 5.6.8)

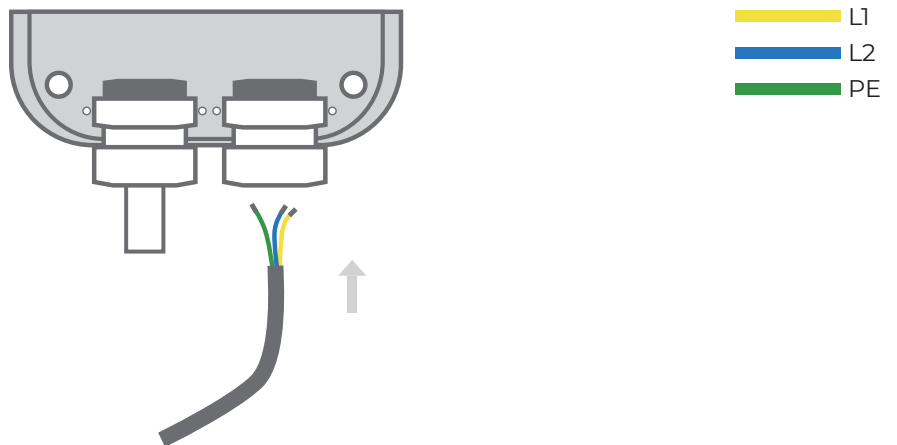

Fig. 5.6.8

9. Ensure the service wiring can easily reach the connectors on the charging station's input terminal block.
10. Fully insert the wires into the connectors on the terminal block with the ground wire on the right. Tighten the screws with a torque of 1.8 Nm. (See Fig. 5.6.9)

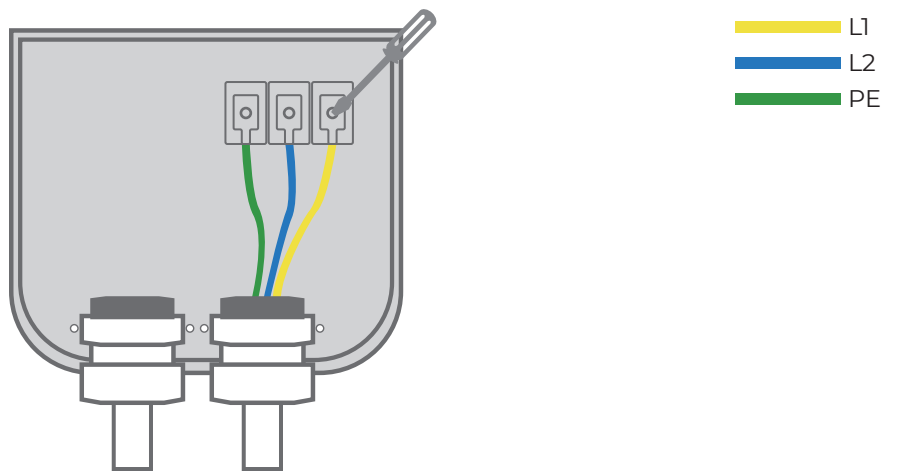
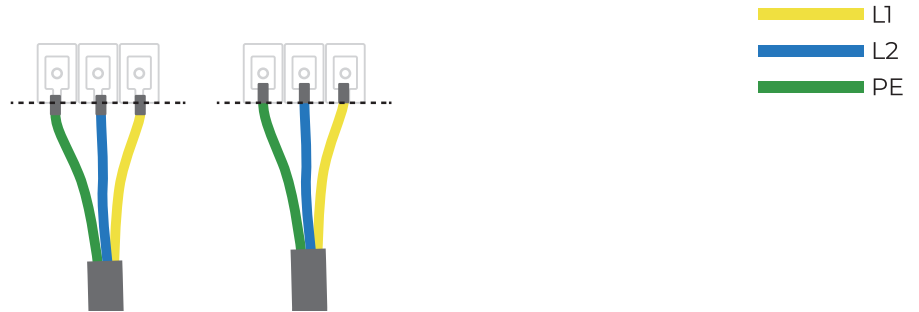

Fig. 5.6.9



- ▷ Before inserting the power input cable, you can deform the service wire with crimping plier.
- ▷ Insert the exposed wires into the corresponding holes, pushing the cables up until the silver conductors are no longer visible.



5.7 Network Cable Installation



- ▷ We strongly recommend that you use a Wi-Fi network when conditions permit. Please refer to Section 6 or the Quick User Guide for details on how to configure your network.

1. Remove the cap of the network cable hole on the bottom right with your hand or a wrench. (See Fig. 5.7.1)
2. Pass through the network cable and crimp the RJ45 (registered jack) connector with the crimp tool.
3. Insert the crimped RJ45 connector into the network plug.

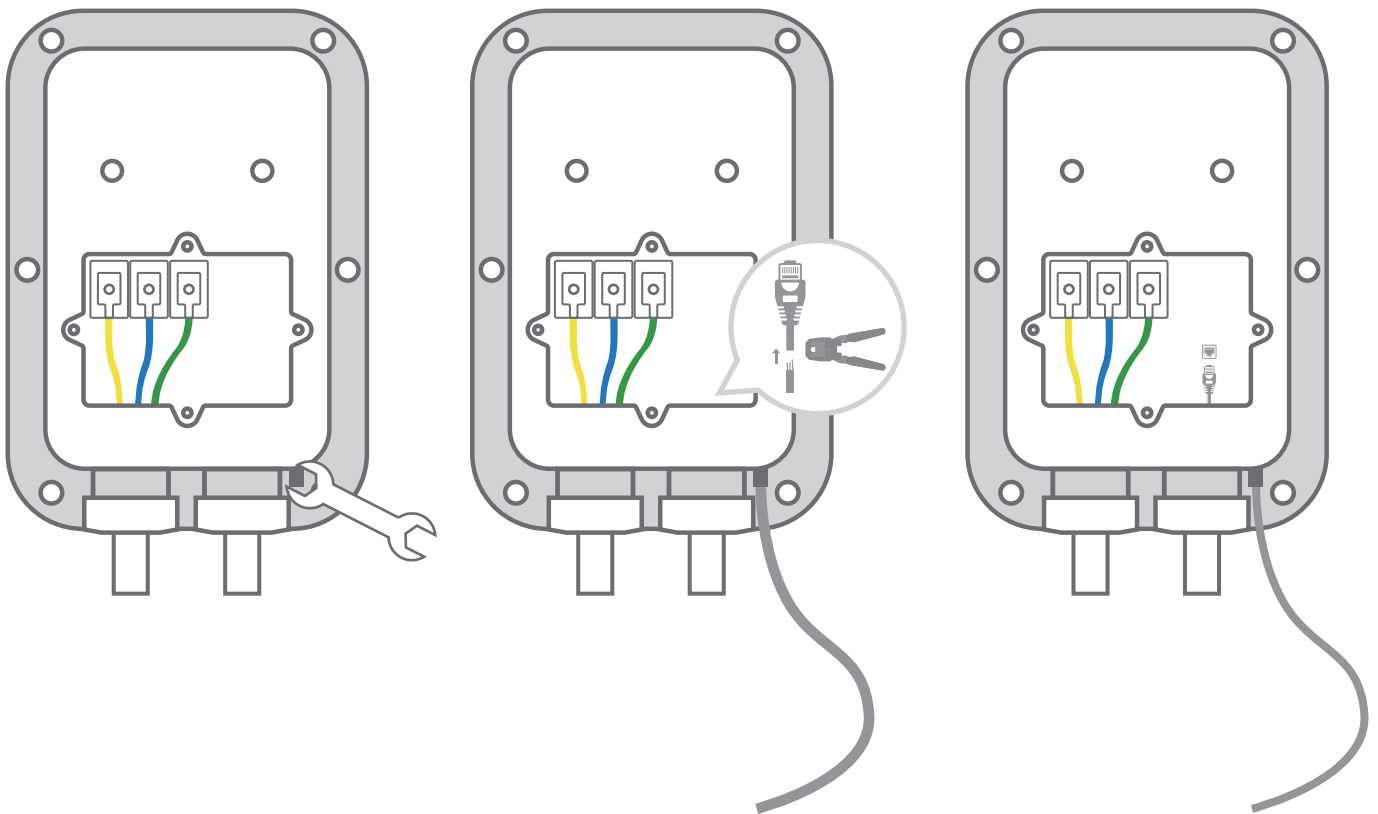
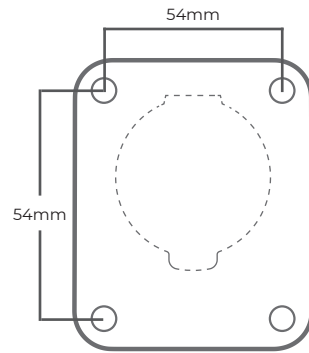

Fig. 5.7.1

5.8 Charging Dock Installation

1. Please make sure the space on the wall is at least 2.12" × 2.12" (54mm × 54mm).



2. Place the installation template on the wall and mark the mounting hole. (See Fig. 5.8.1)

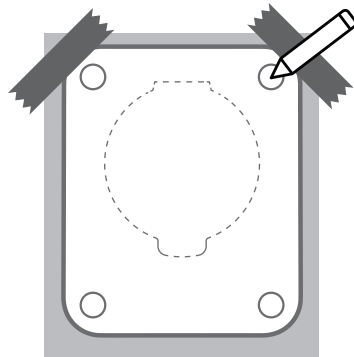

Fig. 5.8.1

3. Drill the mounting holes on the wall with a depth of at least 1.97". (See Fig. 5.8.2)

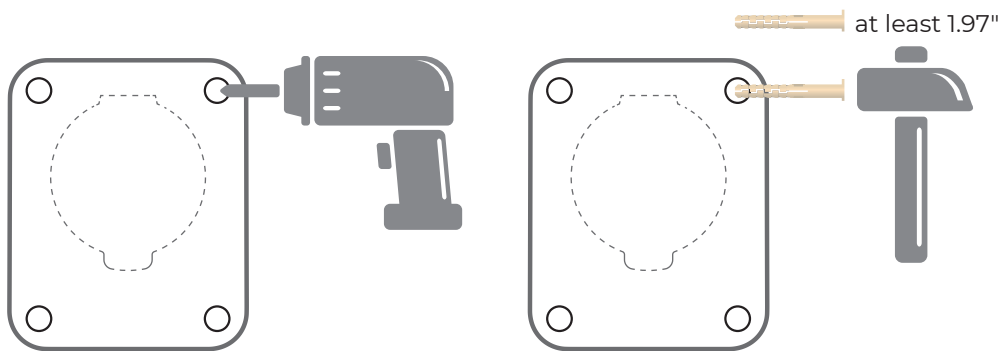

Fig. 5.8.2

4. Fit the charging plug socket into the charging dock (See Fig. 5.8.3)

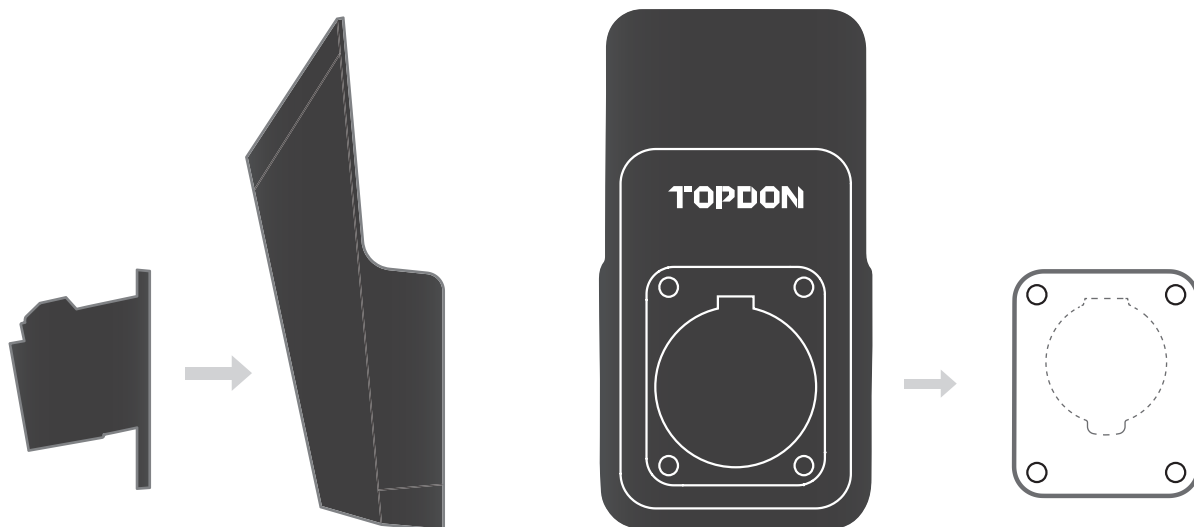

Fig. 5.8.3

5. Fix the charging dock on the wall with the expansion screw in the package. (See Fig. 5.8.4)

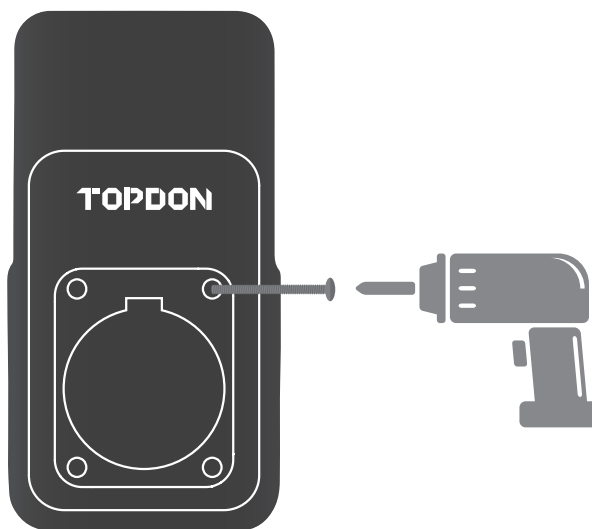

Fig. 5.8.4



Please put the charging plug back to the Charging Dock after each charge.

Section 6—Network Configuration

6.1 Wi-Fi Configuration

1. To configure the Wi-Fi, please download the PulseQ application from the APP Store or Google Play and install the app to your phone. (See Figure 6.1.1)



Fig.6.1.1

2. Register an account with your email address and login. (See Figure 6.1.2)

3. Open the app and tap the User Center, select Charging Station Management (See Figure 6.1.3)

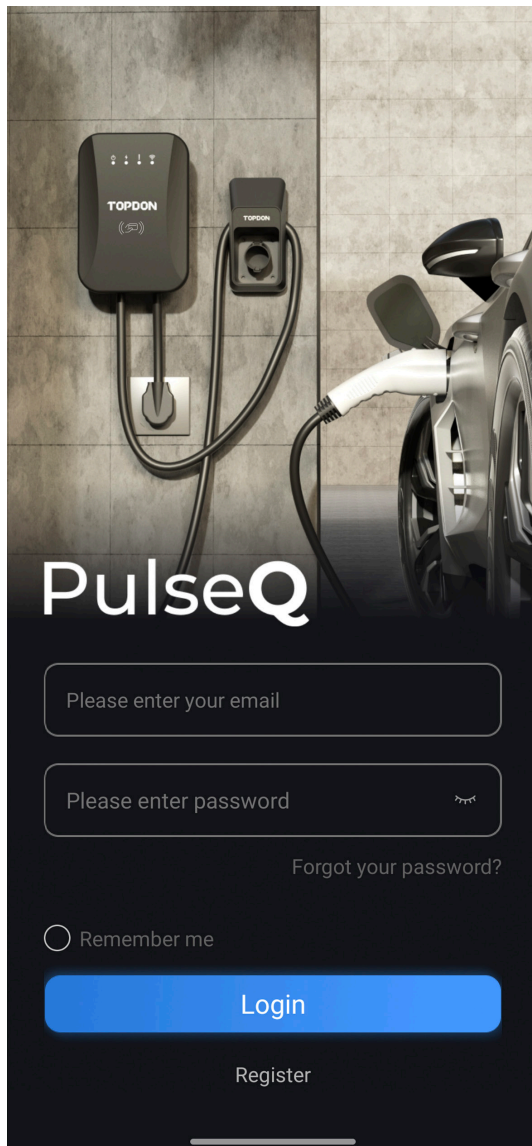

Fig.6.1.2

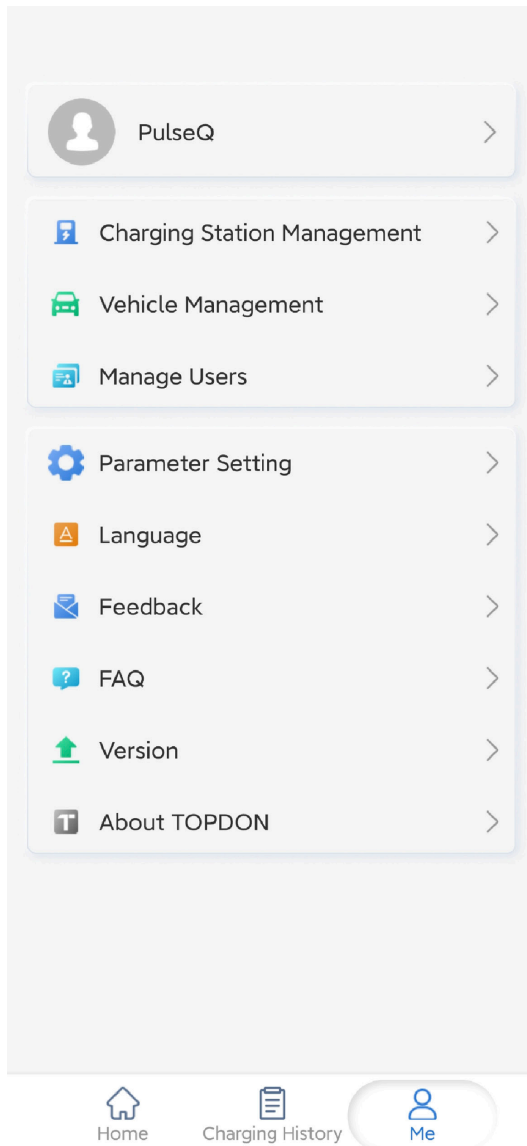

Fig.6.1.3

4. Tap the cross at the bottom right to add your charging station. (See Figure 6.1.4)
5. Select the Wi-Fi network. (See Figure 6.1.5)

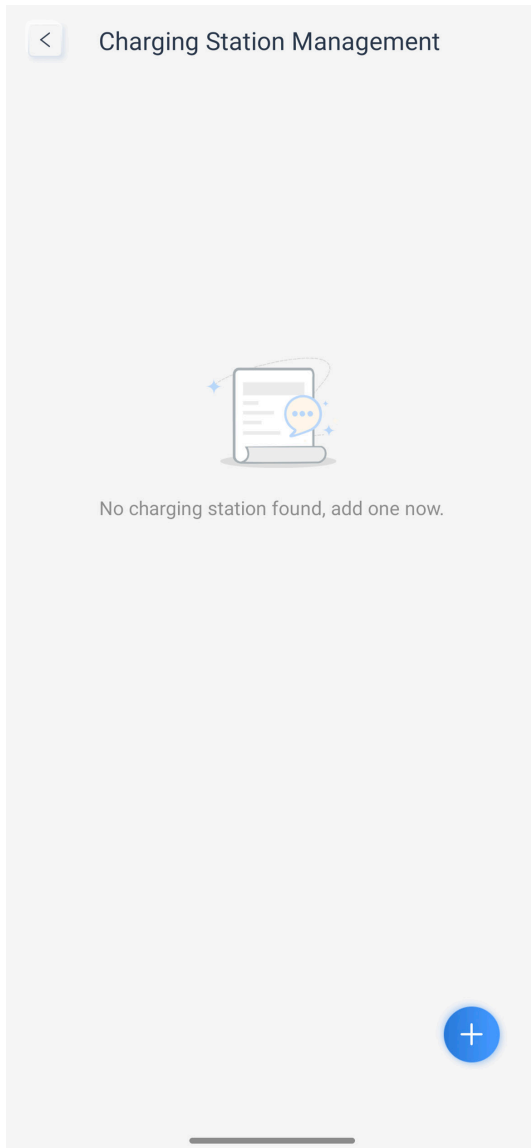

Fig.6.1.4

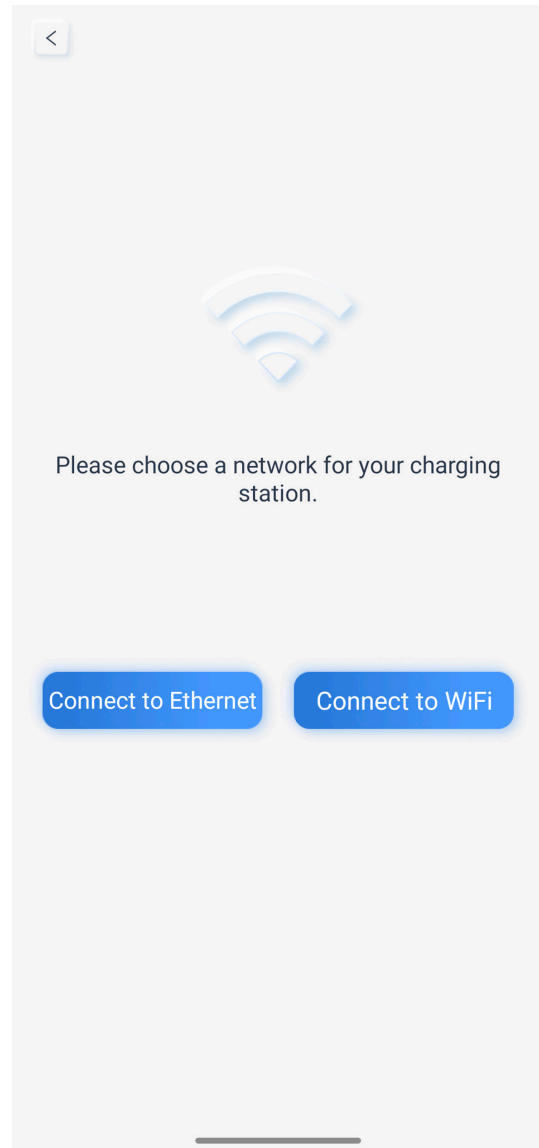

Fig.6.1.5

6. Scan the QR code on the side of the charging station. (See Figure 6.1.6)

7. Tap the button to bind your charging station. (See Figure 6.1.7)

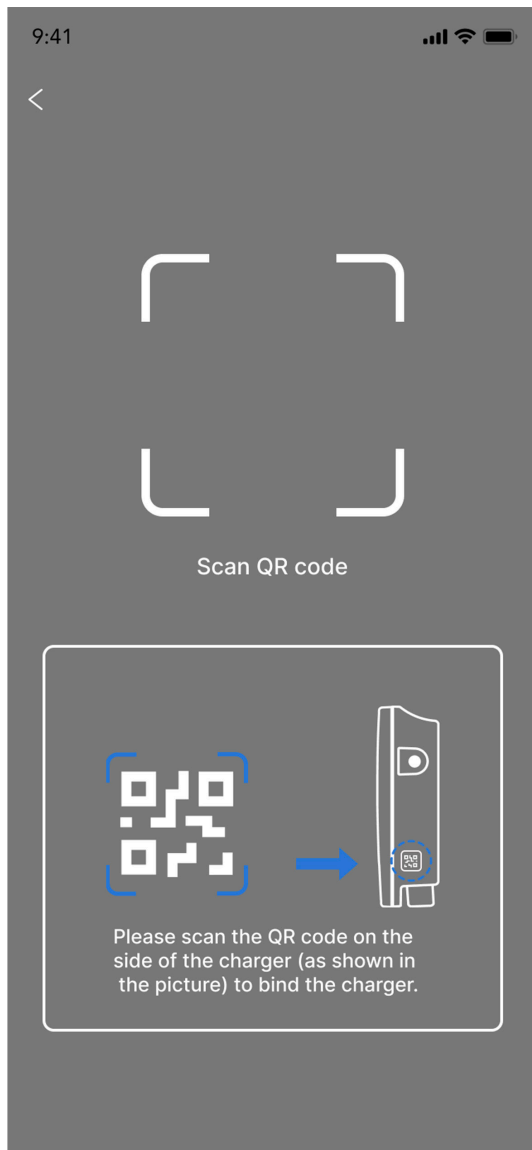

Fig.6.1.6

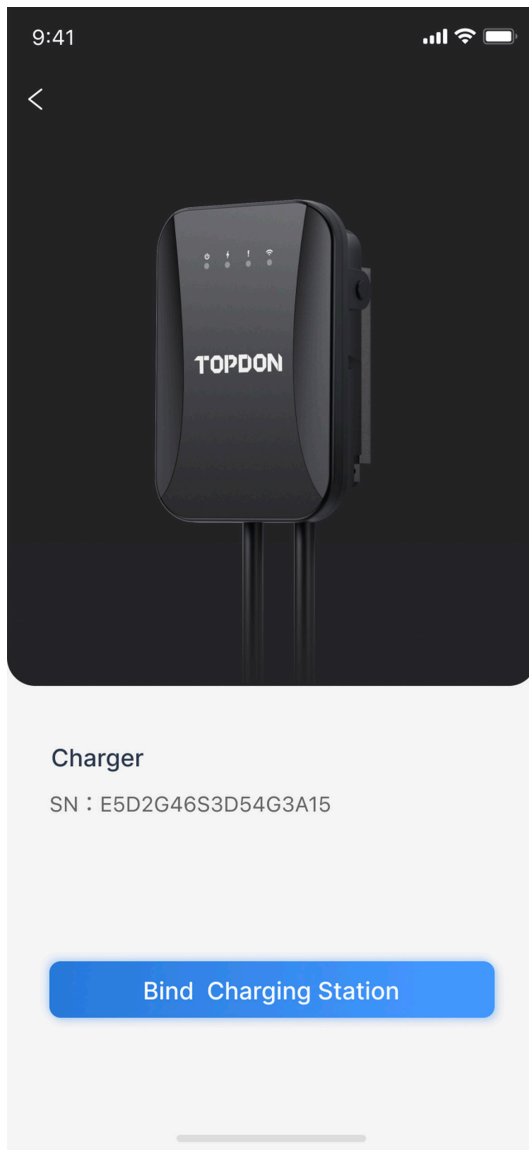

Fig.6.1.7

8. Enter the Wi-Fi name and password and tap Next. (See Figure 6.1.8)



Note: This charging station supports 2.4GHz Wi-Fi only.

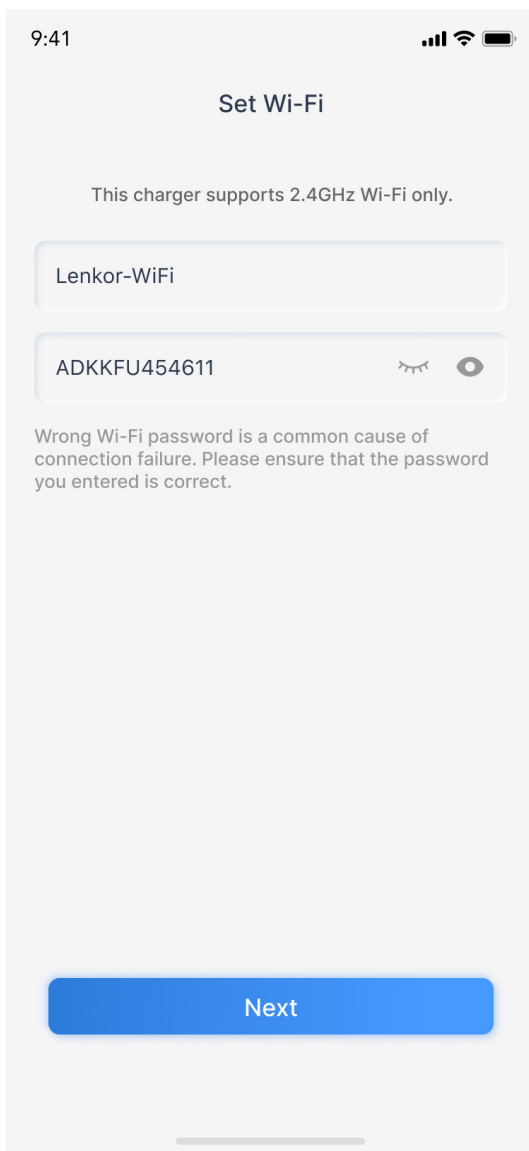

Fig.6.1.8

9. Ensure that the TOPDON-AC-Home can be detected in your available Wi-Fi list. Then, tap Hotspot Available, Connect. (See Figure 6.1.9)
10. Wi-Fi connection will be automatically proceeded. (See Figure 6.1.10)

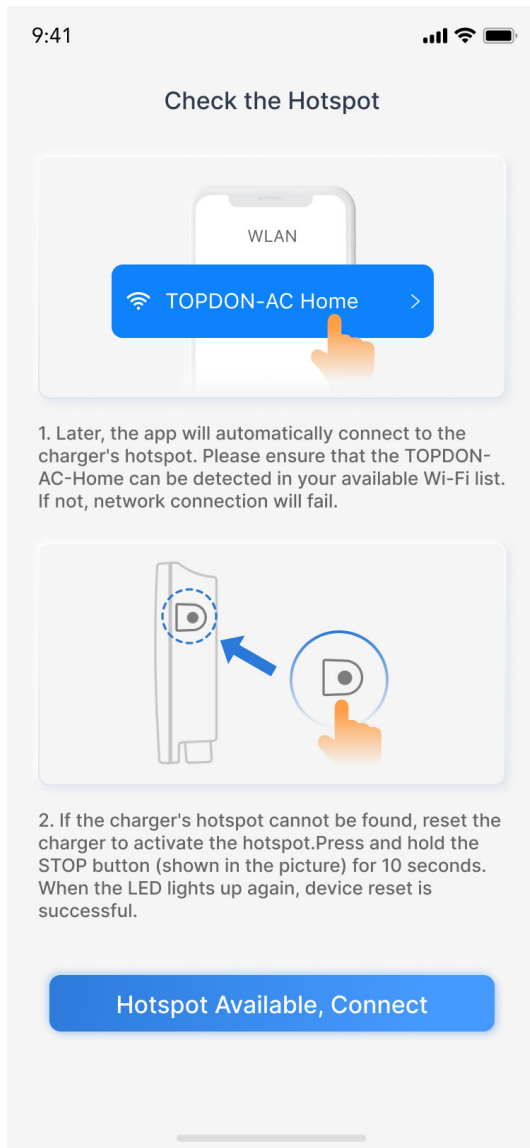

Fig.6.1.9

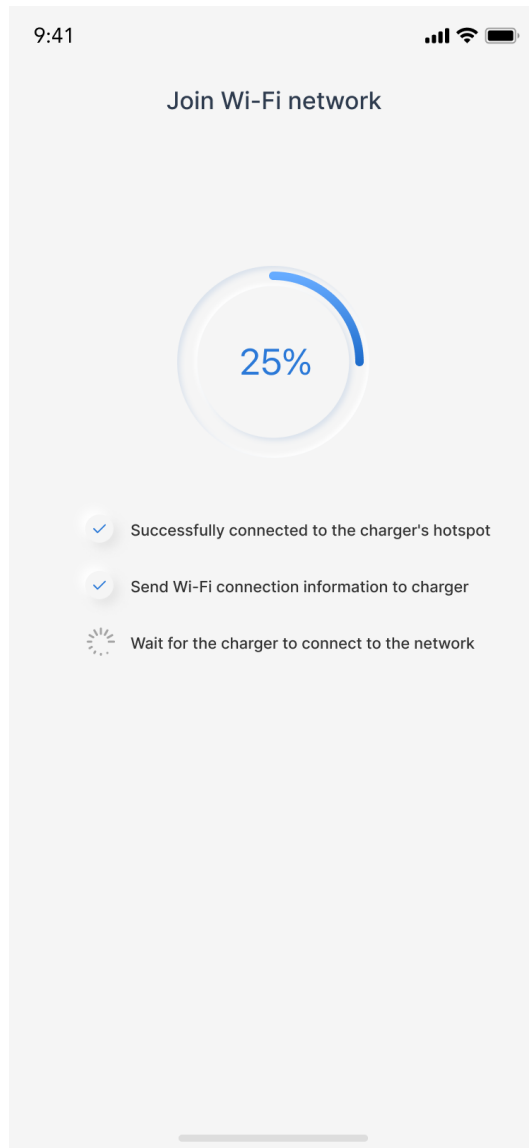

Fig.6.1.10

11. After successful connection, you can rename your charging station.(See Figure 6.11)

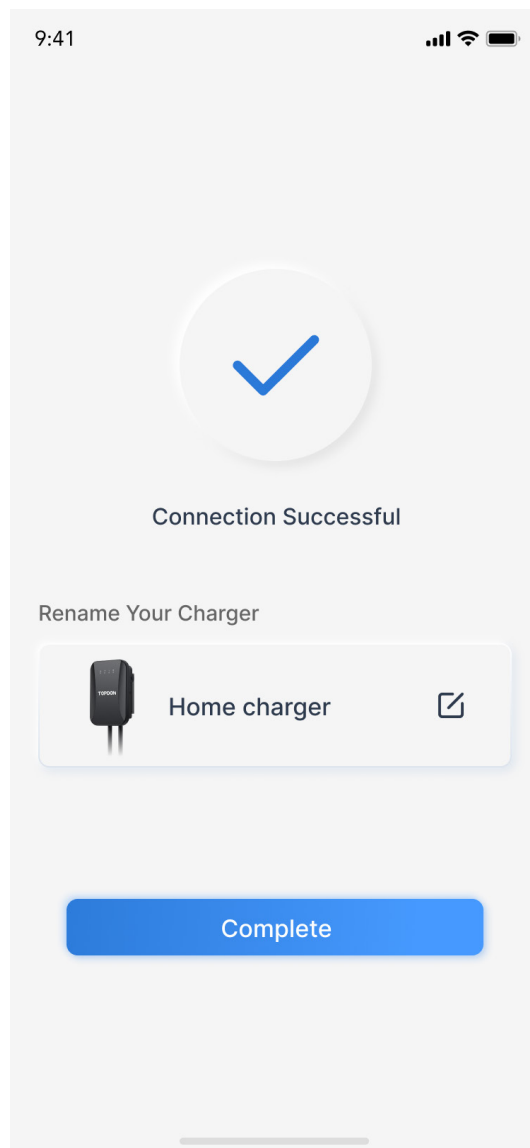

Fig.6.11

6.2 Wired Network Configuration

1. Open the app and tap the User Center, select Charging Station Management. (See Figure 6.2.1)
2. Tap the cross at the bottom right to add your charging station. (See Figure 6.2.2)

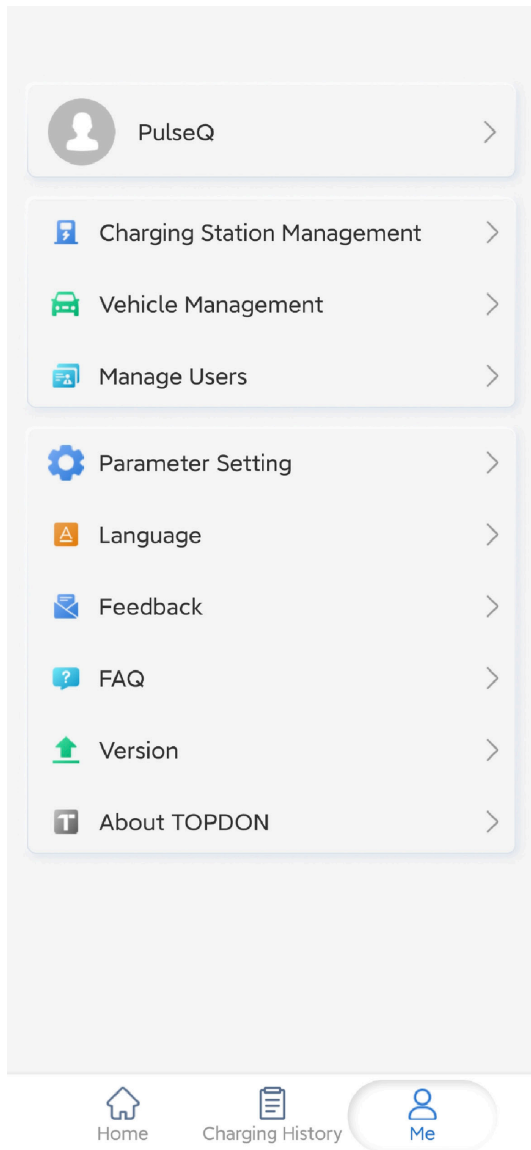

Fig.6.2.1

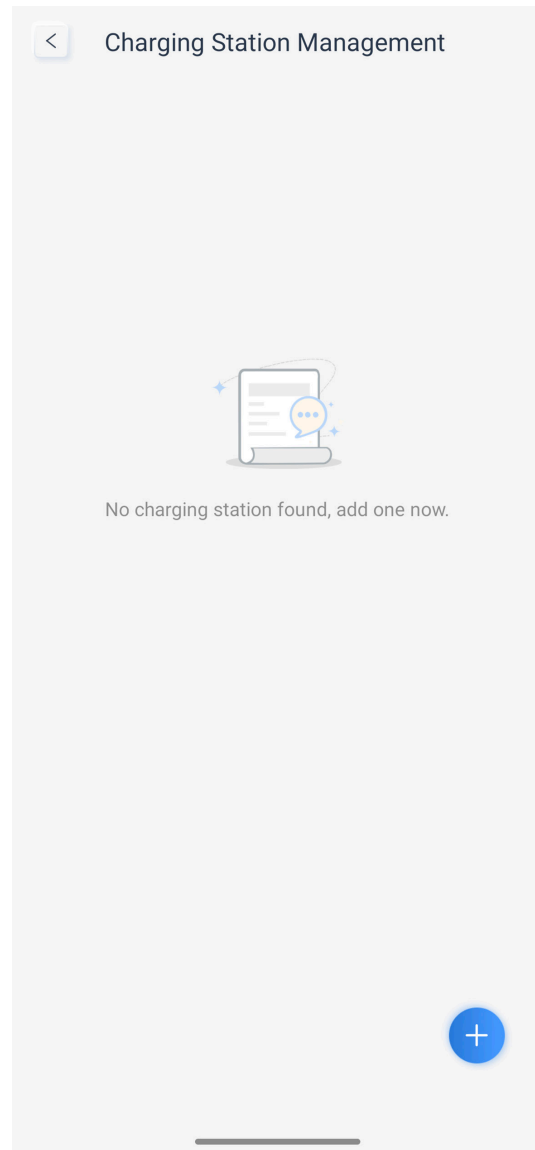

Fig.6.2.3

3. Select the Ethernet Setting. (See Figure 6.2.3)

4. Please read the note carefully and tap Next. (See Figure 6.2.4)

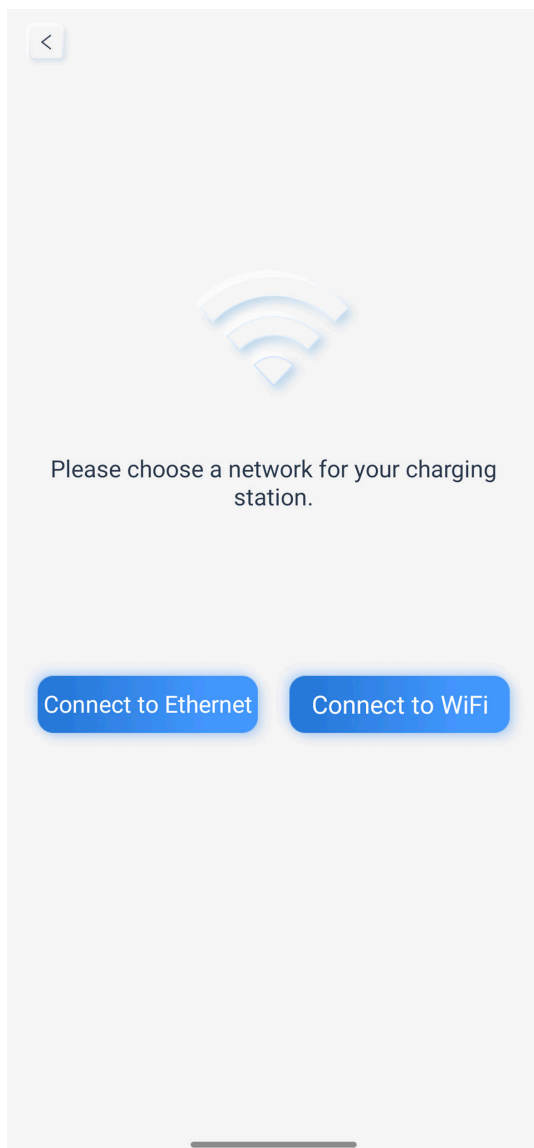

Fig.6.2.3

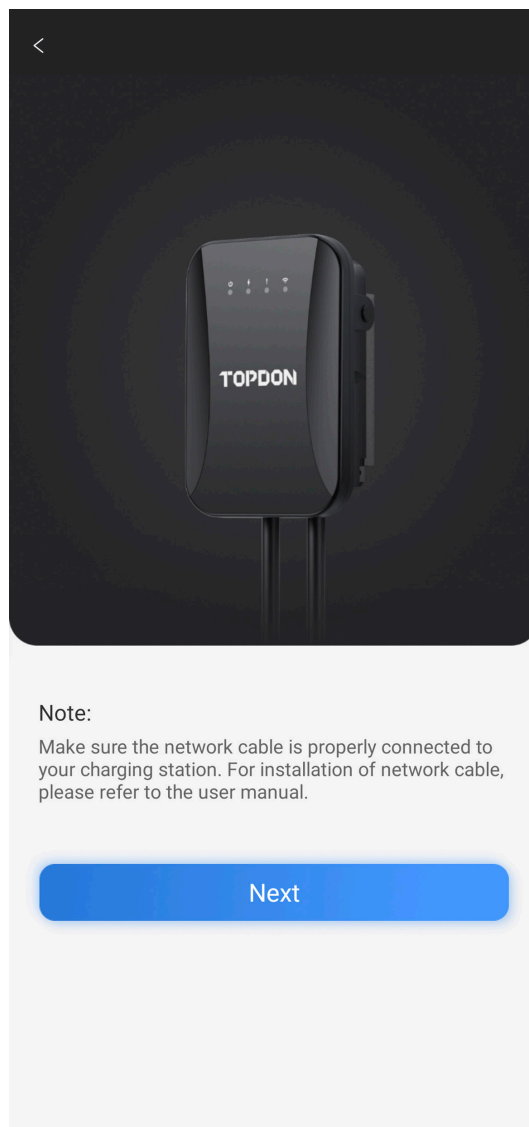

Fig.6.2.4

5. Scan the QR code as prompted to bind the charging station.(See Figure 6.2.5 and 6.2.6)

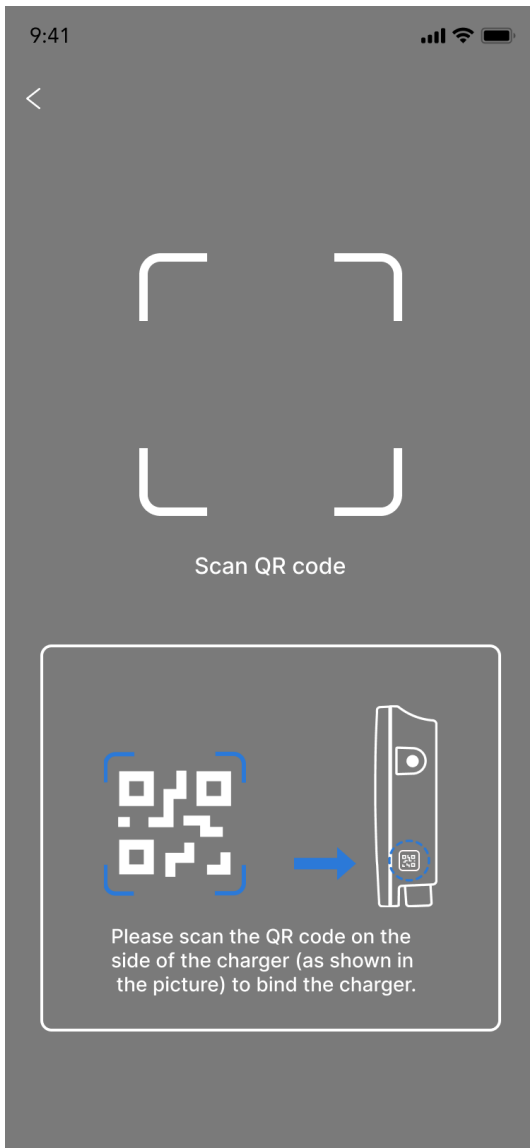

Fig.6.2.5

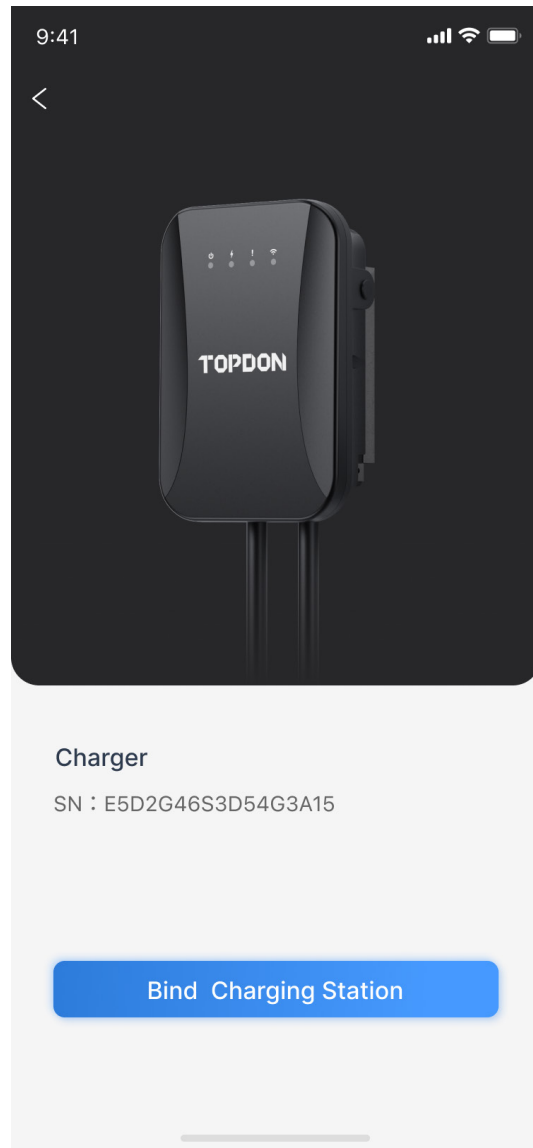





Fig.6.2.6



► The above steps can only be carried out after the ethernet cable is installed to the charging station.

Section 7—LED Indicators

The LED indicators on the panel are used to indicate the status of the charger and the various combinations of indicators are described below.

No.	Icon	Indicator Color	Indicator Status	Connotation
1		Green	ON	Standby status
			Twinkle	Ground fault status
2		Green	ON	Connected to an EV
			BLN control	Charging status
3		Red	Twinkle	Fault status
				Twinkle frequency indicates the fault code
4		Blue	OFF	Unconnected network
			ON	Connected to the network
			ON	Exchanging data with CMS via network.
			Twinkle	Configure WiFi network status

Section 8—Fault Handling

If All LED are not on, please check:



- ▷ Whether the power supply and distribution are normal;
- ▷ Whether the branch breaker is tripped, and close the breaker after troubleshooting;
- ▷ Whether the connection is correct; if the cable comes off, it should be properly reconnected and tightened.

The charger is automatically protected in the event of a fault. The fault information and handling methods are as follows.

Indicator Twinkle	Fault Code	Handling Method
• 1×slow, 1×fast	Fault code 11: CP voltage anomaly	<ul style="list-style-type: none"> • Check the connection of charging plug and socket. • Disconnect and reconnect the charging plug.
• 1×slow, 3×fast	Fault code 13: Undervoltage input	<ul style="list-style-type: none"> • Check whether input plug is reliably connected. • Check whether the input voltage is abnormal.
• 1×slow, 4×fast	Fault code 14: Overvoltage input	<ul style="list-style-type: none"> • Check whether the input voltage is abnormal.
• 1×slow, 5×fast	Fault code 15: Over-temperature protection	<ul style="list-style-type: none"> • Check whether the charger is covered or installed in a high temperature environment.
• 1×slow, 6×fast	Fault code 16: Metering fault	<ul style="list-style-type: none"> • Power off and restart the device.
• 1×slow, 7×fast	Fault code 17: Leakage protection	<ul style="list-style-type: none"> • Check whether the charging plug, charging cable and EV socket are damaged or wet. • Power off, disconnect and reconnect the charging plug and restart.
• 1×slow, 8×fast	Fault code 18: Output shortage	<ul style="list-style-type: none"> • Check whether the charging plug and its cables are damaged or wet.
• 1×slow, 9×fast	Fault code 19: Output overcurrent	<ul style="list-style-type: none"> • Check whether the charging connector is correctly connected. • Check whether the OBC is normal. • Check the set of output maximum current.
• 2×slow, 1×fast	Fault code 21: EV response timeout	<ul style="list-style-type: none"> • Battery of EV is full or the charging plug is not properly connected. • Disconnect and reconnect the charging plug.
• 2×slow, 2×fast	Fault code 22: EV not supported	<ul style="list-style-type: none"> • This EV does not meet the SAE J1772 and cannot be charged.

• 2×slow, 3×fast	Fault code 23: Relay sticking	• The device is damaged and needs to be returned to the factory for repair.
• 2×slow, 4×fast	Fault code 24: CCID sensor fault	• The sensor is damaged and needs to be returned to the factory for repair.
• 2×slow, 5×fast	Fault code 25: Ground fault	• Charger is not grounded; input power socket and input plug need to be checked.

Section 9—Warranty

TOPDON's Limited Warranty

TOPDON warrants to its original purchaser that the company's products will be free from defects in material and workmanship for 36 months (charging station) and 12 months (charging cable) from the date of purchase (Warranty Period).

For the defects reported during the Warranty Period, TOPDON will either repair or replace the defective part or product according to its technical support analysis and confirmation.

TOPDON shall not be liable for any incidental or consequential damages arising from the device's use, misuse, or mounting.

Some states do not allow limitation on how long an implied warranty lasts, so the above limitations may not apply to you.

This limited warranty is void under the following conditions:

- Misused, disassembled, altered or repaired by unauthorized stores or technicians.
- Careless handling and operation's violation.

Notice: All information in this manual is based on the latest information available at the time of publication and no warranty can be made for its accuracy or completeness. TOPDON reserves the right to make changes at any time without notice.

Section 10—FCC

This device complies with Part 15 of the FCC Rules. Its operation is subject to the following two conditions: (1) this device may not cause harmful interference, and (2) this device must accept any interference received, including interference that may cause undesired

EN I 29

operation.

Note: This equipment has been tested and found to comply with the limits for a Class B digital device, pursuant to Part 15 of the FCC Rules.

These limits are designed to provide reasonable protection against harmful interference in a residential installation.

This equipment generates, uses and can radiate radio frequency energy and, if not installed and used in accordance with the instructions, may cause harmful interference to radio communications.

However, there is no guarantee that interference will not occur in a particular installation.

If this equipment does cause harmful interference to radio or television reception, which can be determined by turning the equipment on and off, the user is encouraged to try to correct the interference by one or more of the following measures:

- Reorient or relocate the antenna.
- Increase the distance between the equipment and receiver.
- Connect the equipment into an outlet on a circuit different from the one connected to the receiver.
- Consult a dealer or an experienced radio/TV technician for help."

"FCC Caution

This device complies with part 15 of the FCC Rules. Operation is subject to the following two conditions:

(1) This device may not cause harmful interference, and

(2) this device must accept any interference received, including interference that may cause undesired operation.

The user manual or instruction manual for an intentional or unintentional radiator shall caution the user that changes or modifications not expressly approved by the party responsible for compliance could void the user's authority to operate the equipment. In cases where the manual is provided only in a form other than paper, such as on a computer disk or over the Internet, the information required by this section may be included in the manual in that alternative form, provided the user can reasonably be expected to have the capability to access information in that form.

RF Exposure Statement

This equipment must be installed and operated in accordance with provide instructions and the antenna used for this transmitter must be installed to provide a separation distance of at least 20 cm from all persons and must not be co-located or operation in conjunction with any other antenna or transmitter. End-users and installers must be provided with antenna installation instructions and transmitter operating conditions for satisfying RF exposure compliance.



TEL

**86-755-21612590
1-833-629-4832 (NORTH AMERICA)**



EMAIL

**SUPPORT@TOPDON.COM
SUPPORT@TOPDON.US**



WEBSITE

**WWW.TOPDON.COM
WWW.TOPDON.US**



FACEBOOK

@TOPDONOFFICIAL



TWITTER

@TOPDONOFFICIAL

