

For Services and Support



TEL

86-755-21612590
1-833-629-4832 (North America)



EMAIL

SUPPORT@TOPDON.COM



WEBSITE

WWW.TOPDON.COM



FACEBOOK

@TOPDONOFFICIAL



TWITTER

@TOPDONOFFICIAL



RoHS



FR

Papier



TOPDON

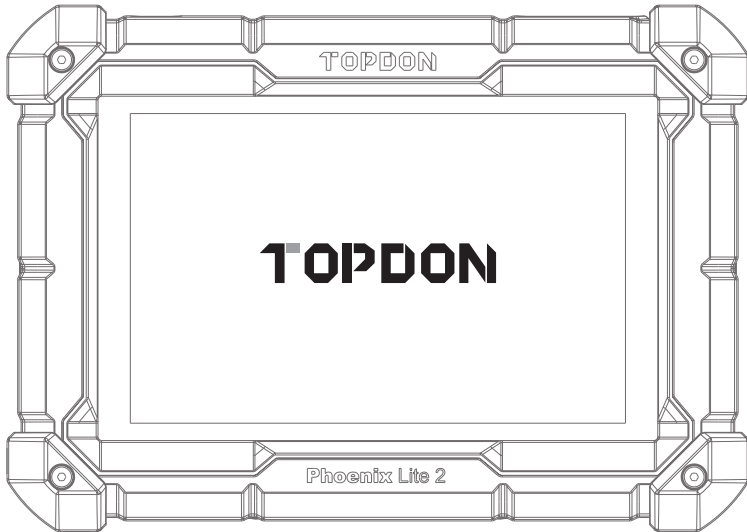

Phoenix Lite 2

Smart Automotive Diagnostic System

USER MANUAL

Contents

Welcome	3
About.....	3
Package List	3
Compatibility	3
Notice.....	4
General Information of OBDII (On-Board Diagnostics II).....	4
Diagnostic Trouble Codes (DTCs)	4
Product Descriptions	5
Preparation & Connection.....	7
Operation Introduction.....	12
Technical Specification.....	36
Warnings.....	37
Cautions.....	37
FAQ.....	38

Welcome

Thank you for purchasing TOPDON Smart Automotive Diagnostic System Phoenix Lite 2. Please read and understand this user manual prior to the operation.

About

TOPDON Phoenix Lite 2 features comprehensive diagnostic capabilities. The accuracy of test readings, expanded vehicle coverage, improved speed and an abundance of user-friendly nature make this diagnostic tablet stand out in its class and give mechanics and professionals a great deal of help in their diagnostic work.

Package List

- Phoenix Lite 2
- Phoenix MDCI Lite
- OBDI Adapter BOX Transfer Line
- OBDII Extension Cable
- Cigarette Lighter Cable
- Type-C to USB Cable
- Battery Clamps/Cable Set
- Power Adaptor
- User Manual
- Password Letter
- Non-Standard OBDII Adapter*10
- Fuse ($\varphi 5 \times 20\text{mm}$)*4
- Fuse ($\varphi 6 \times 30\text{mm}$)*2

Compatibility

TOPDON Phoenix Lite 2 is compatible with the following protocols:

- ISO 9142-2
- ISO 14230-2
- ISO 15765-4
- K/L-Line
- Flashing Code
- SAE-J1850 VPW
- SAE-J1850 PWM
- CAN ISO 11898
- Highspeed
- Middlespeed
- Lowspeed and Singlewire CAN
- GM UART
- UART Echo Byte Protocol
- Honda Diag-H Protocol
- TP 2.0
- TP 1.6
- Fault-Tolerant CAN

Notice

Phoenix Lite 2 may automatically reset while being disturbed by strong static electricity. THIS IS A NORMAL REACTION.

This user manual is subject to change without written notice.

Read the instruction carefully and use the unit properly before operating. Failure to do so may cause damage and/or personal injury, which will void the product warranty.

General Information of OBDII (On-Board Diagnostics II)

The OBDII system is designed to monitor emission control systems and key engine components by performing either continuous or periodic tests of specific components and vehicle conditions, which will offer three pieces of such valuable information:

- Whether the Malfunction Indicator Light (MIL) is commanded "on" or "off";
- Which, if any, Diagnostic Trouble Codes (DTCs) are stored;
- Readiness Monitor status.

Diagnostic Trouble Codes (DTCs)

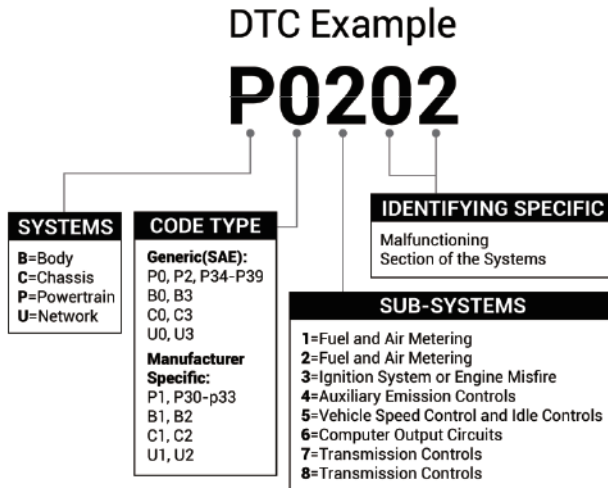

Product Descriptions

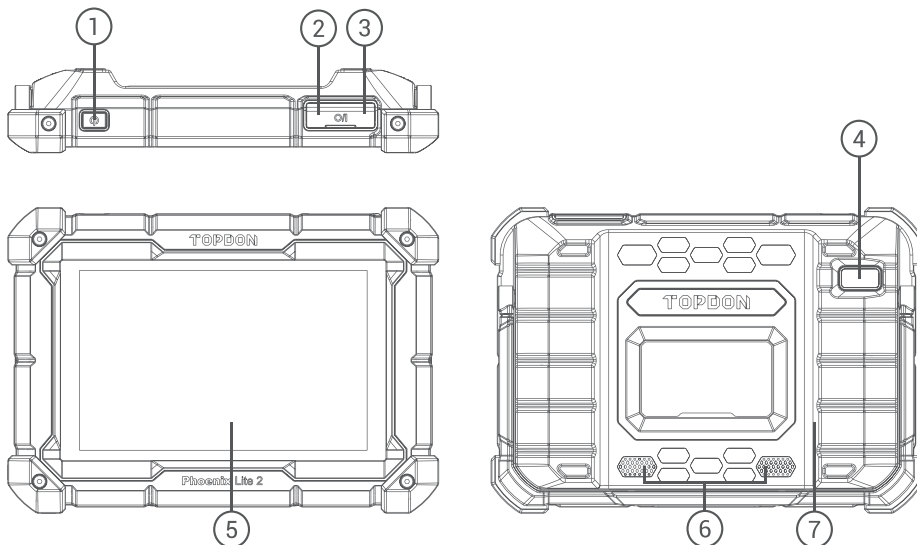

NO.	Name	Descriptions
1	Power Button	<ul style="list-style-type: none"> • Hold the button for 3 seconds to turn the tablet on, or off. • Hold the button for 10 seconds for a forced restart.
2	USB Port	Can be used to charge 5V electronic devices.
3	Type-C Charging Slot	For charging the tablet.
4	Rear Camera	Snapshot the view ahead of the camera.
5	8" Touchable Screen	Show test results.
6	Loudspeaker	Convert an audio signal into a corresponding sound.
7	Adjustable Stand	Able to keep the device standing on the desk, or hang the device on the steering wheel.

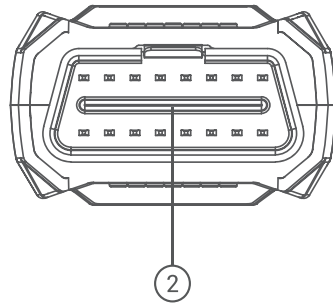
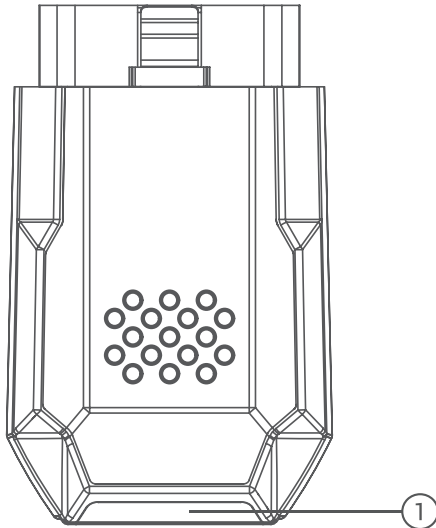

NO.	Name	Descriptions
1	Indicator Light	Three LED indicators are provided on each side, and the prompts are as follows: <ul style="list-style-type: none"> • Power: Red lights to indicate that the power is on • Vehicle: Green flashing means it is communicating with the vehicle • I/O: Purple, long light means the USB is connected to the host
2	Diagnostic Port	Plug in the diagnostic cable whose OBD 16-pin connector is linked to the DLC of the vehicle.

Preparation & Connection

1. Turn the ignition off.

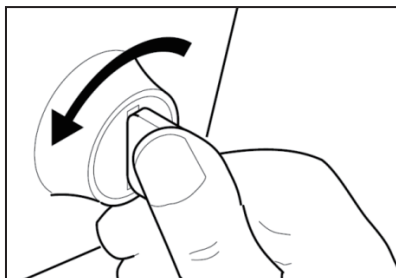

2. Locate the vehicle's DLC port.

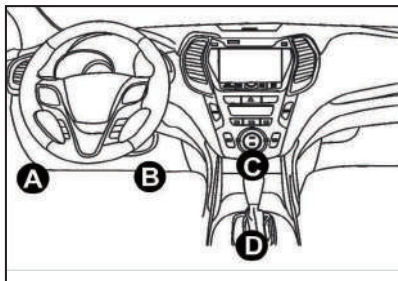

3. Plug the TOPDON Phoenix MDCI Lite dongle into the vehicle's DLC port.

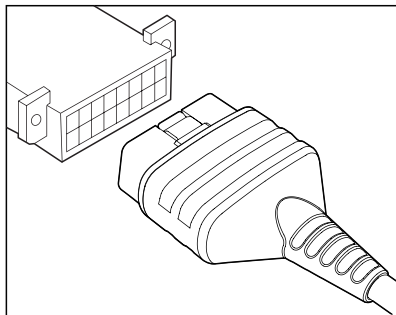

4. Turn the ignition on. The engine can be off or running.
5. Fully charge the Phoenix Lite 2, and hold the power button for 3 seconds to turn the tablet on. The tablet will start initializing and enter the following interface:



Note: Don't connect or disconnect any test equipment with the ignition on or engine running.

6. Language Setting

Select operating language in the following interface:

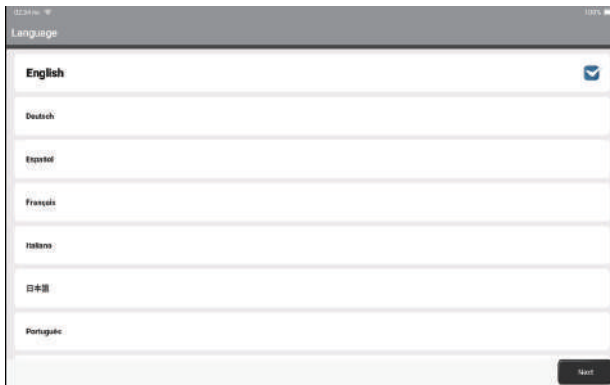

7. Choose Time Zone

Choose the time zone of your current location. The system will automatically configure the time.

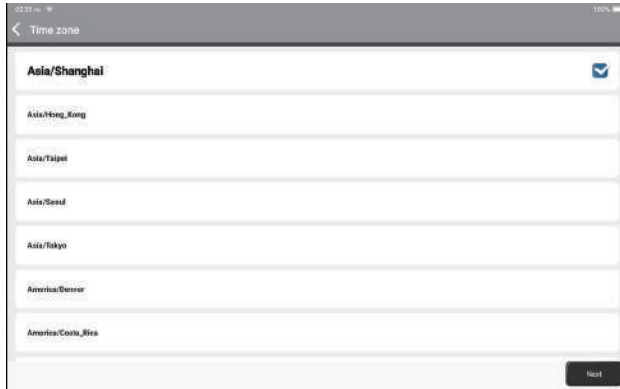

8. Connect Wi-Fi

The system will automatically search all available Wi-Fi networks. Please connect to the trusted Wi-Fi.

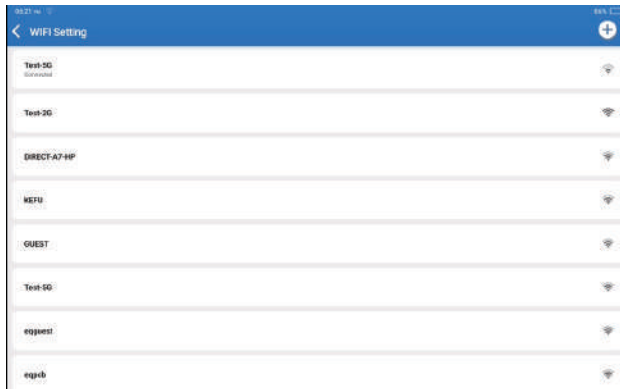

9. User Agreement

Please read all the terms and conditions of the user agreement carefully. Select “Agree with above terms”.

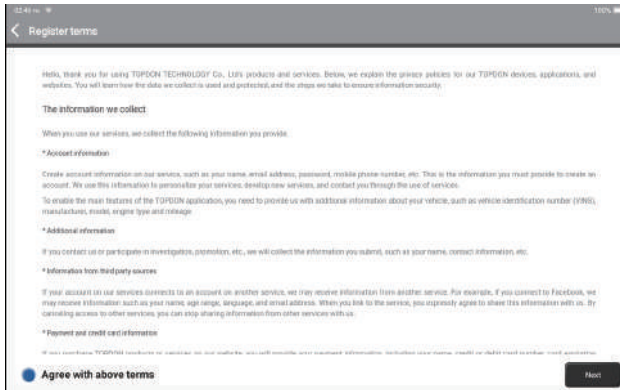

Tap “Next” to log in. The following page will appear:

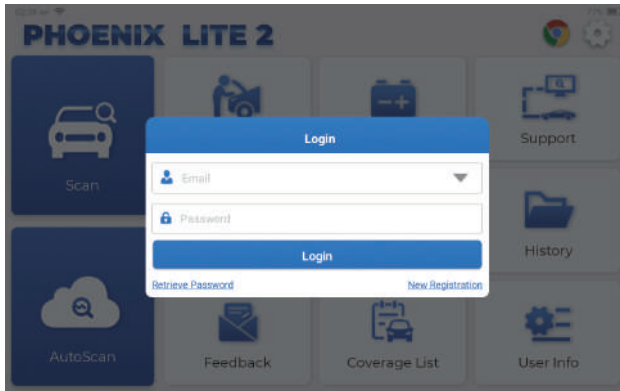

10. Create an Account

You can log in with an available TOPDON account, or register a new account with a valid e-mail address.

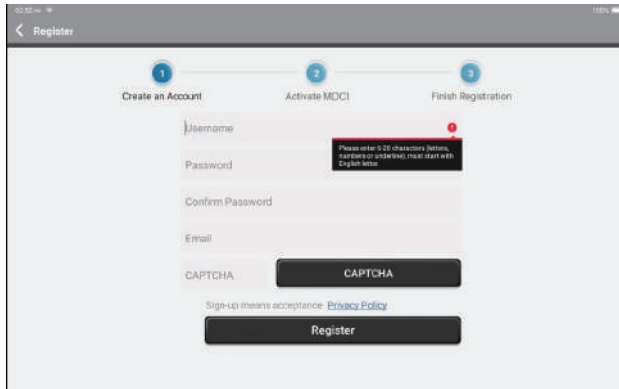

After inputting the information required, tap "Register". The tablet will enter the MDCI Activation procedure.

11. MDCI Activation

Input the serial number and activation code to activate and bind the diagnostic MDCI dongle. Both the serial number and the activation code are available in the "Password Letter". The activation procedure is necessary for using the Phoenix Lite 2 properly.

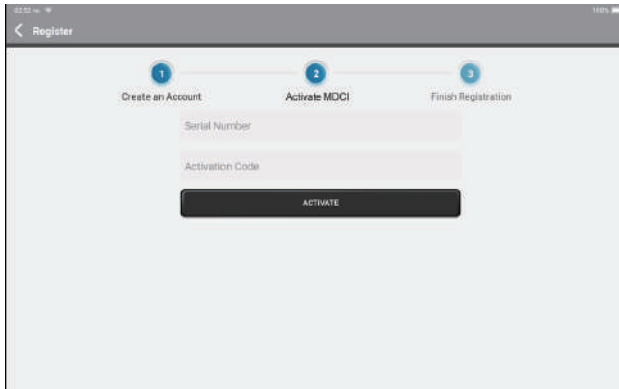

Tap "Activate" to finish the procedure, and get started with Phoenix Lite 2.

Operation Introduction

TOPDON Phoenix Lite 2 features an array of practical functions, including Scan, AutoScan, Services, Tester, Support, Update, Library, History, Feedback, Coverage List and User Info.



TOPDON Phoenix Lite 2 supports AutoScan and Scan covering OBDII diagnosis, full system diagnosis for most modern vehicle models worldwide.

1. AutoScan (Intelligent Diagnosis)

Plug the Phoenix MDCI Lite dongle into the vehicle's DLC port.

Tap "AutoScan" on the Home Menu after connecting to the vehicle.

The tool will start the AutoScan procedure, and automatically read the vehicle's VIN information, as shown below:

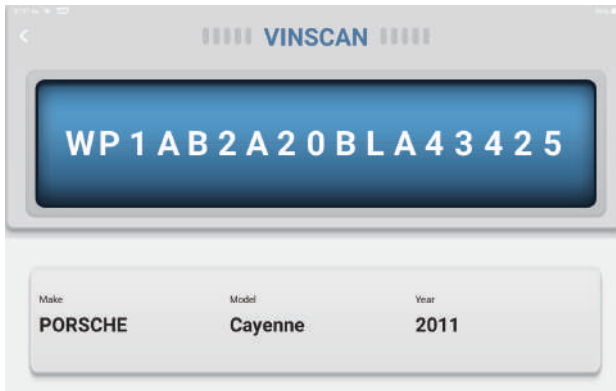

Note: A highly stable and solid network connection is required for successful VIN access.

2. Scan(Diagnosis)

If Phoenix Lite 2 fails to get access to the vehicle VIN data automatically, tap "Scan" on the Home Menu. The following page will appear:

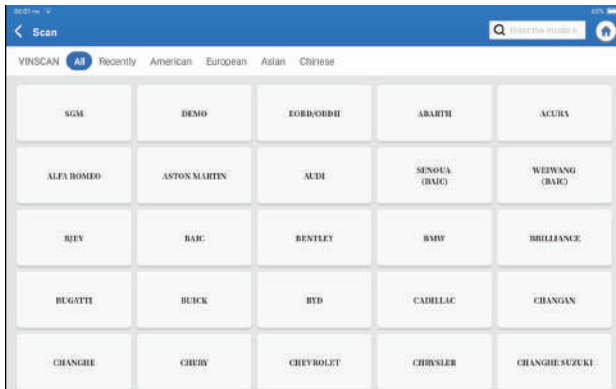

There are two ways in this module to get access to vehicle diagnostic functions.

2.1 The first way is using "VINSCAN".

Tap "VINSCAN". The following page will appear:

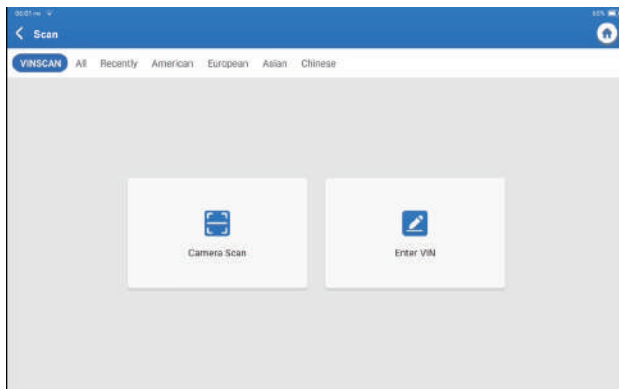

2.1.1 Tap "Camera Scan". The following page will appear

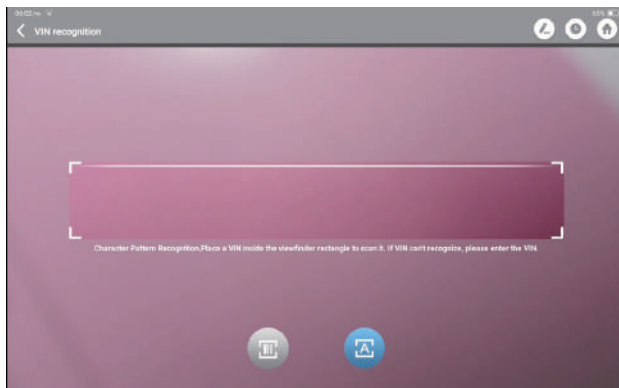

Tap  to scan the VIN barcode. If the VIN barcode cannot be recognized, please manually input the VIN.

Tap  to scan the VIN character. If the VIN character cannot be recognized, please manually input the VIN.
After scanning, the following page will appear:

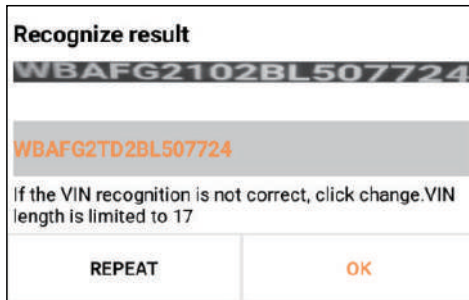

Note: the VIN code in yellow can be modified if it isn't correct.

2.1.2 Or, tap "Enter VIN", the following page will appear:

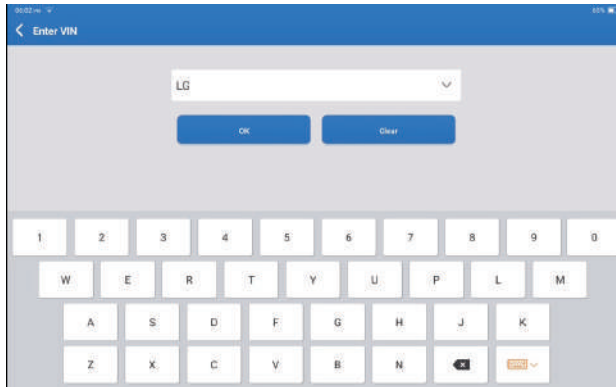

You need to input the vehicle's VIN manually.

Note: VIN characters need to be capital letters A through Z and numbers 1 through 0. However, the letters I, O, and Q won't be used in order to avoid misreading. No symbols or spaces are allowed in the VIN.

After reading the VIN information successfully, the following page will appear:

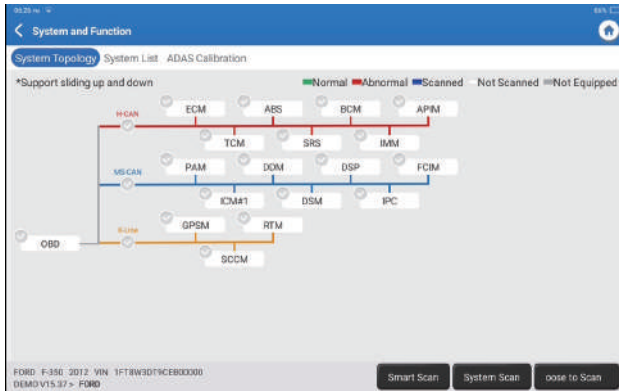

2.2 The second way is manually selecting the vehicle's make, model, and year.

Tap a corresponding diagnostic software logo on the following page:

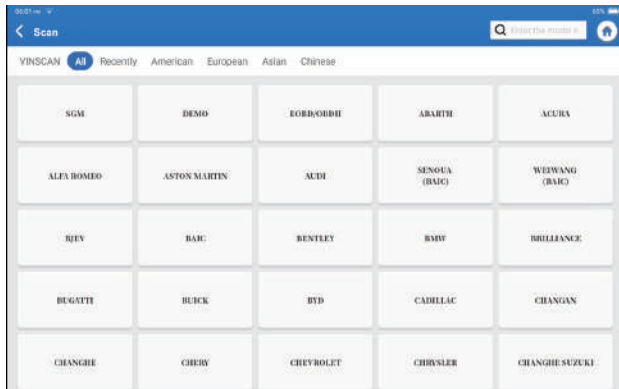

Take "Demo" as an example. The following page will appear:

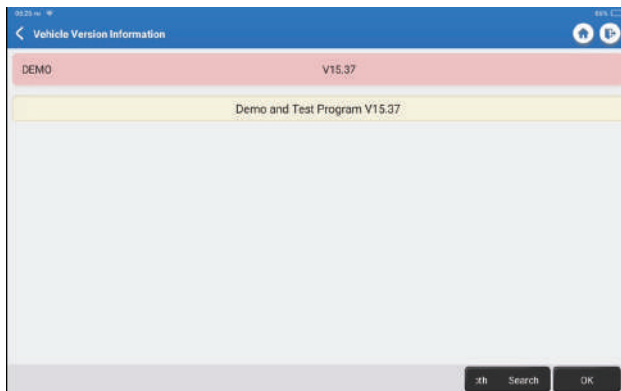

Select the diagnostic software version to continue.
The tablet will automatically navigate to the Show Menu:

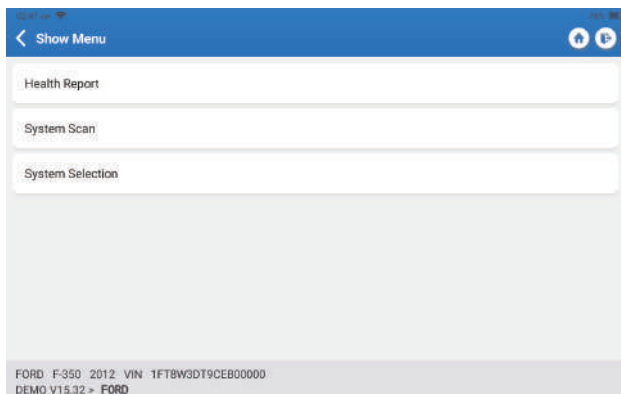

2.2.1 System Scan

This function will automatically scan all systems of the vehicle.



Scan the manually selected vehicle electric control system. Tap "PCM" -> "Enter" as an example to demonstrate. The following page shows the selection interface.

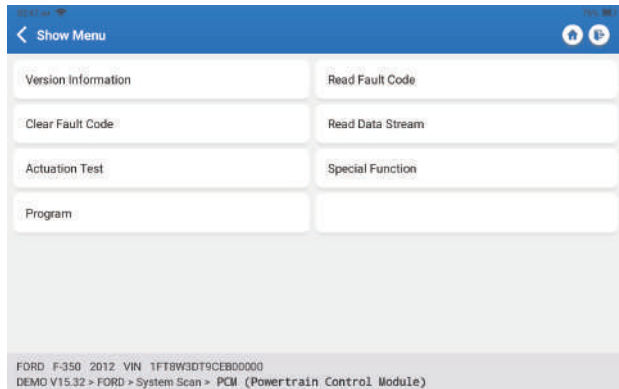

Note: This function will be available only when the diagnostic software supports it.

A. Version Information

This function reads the current version information of ECU.

B. Diagnostic Trouble Code

This function can read the Diagnostic Trouble Codes (DTCs) in the ECU memory, helping quickly identify the cause of the vehicle breakdown.

Tap "Read Fault Code". The screen will display diagnostic results.

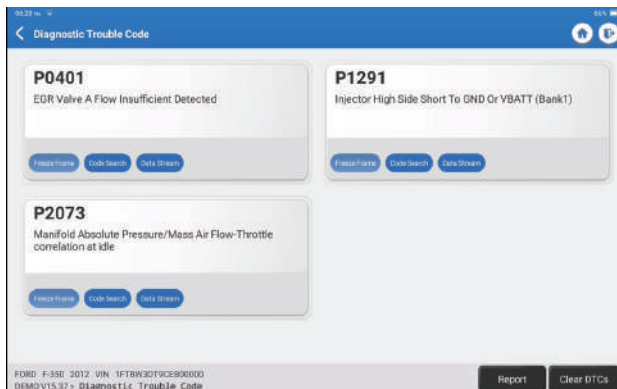

*Explanation of terms:

- Freeze Frame: Take a snapshot of specific data streams for verification when the DTC occurs.
- Code Search: Query DTC information through Google Chrome.
- Data Stream: Return to the data stream page.
- Report: Save the current diagnosis result as a diagnosis report.

C. Clear Fault Code

This function can clear the DTC of the ECU memory of the tested system.

D. Read Data Stream

This function can read and display real-time data and parameters.

Tap "Read Data Stream". The following page will appear:

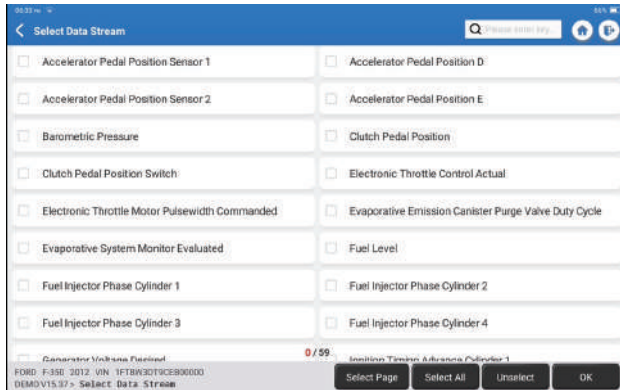

Select the data stream and tap "OK":

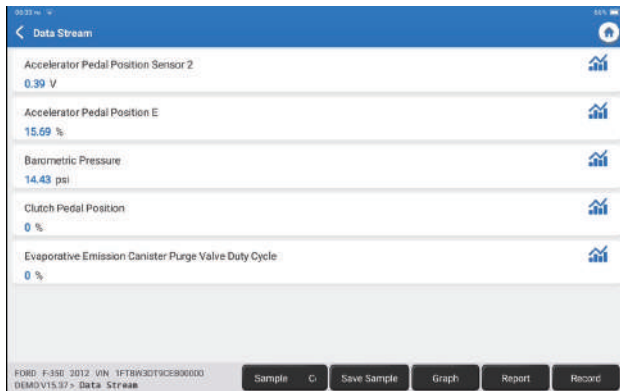



The system can display data streams in three modes:

- 1) Value (default): Shows parameters with numbers and lists.
- 2) Graph: Displays parameters with wave patterns.
- 3) Combine: The graphs can be merged for easier comparisons.

*Explanation of terms:

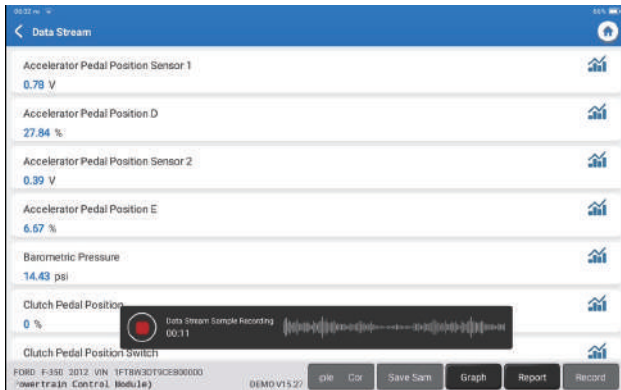
- **Save Sample:** You can save the current Data Stream as a Sample when the vehicle is running normally, and use this Sample Data Stream for future comparison and analysis. Tap "Save Sample" to start recording the sample data stream. The following page will appear:



Once the recording process is complete, tap "  " to end the recording. The following page will appear:

The screenshot shows the 'Data Stream Sample' app interface. At the top, there is a blue header with a back arrow and the title 'Data Stream Sample'. Below the header, a table displays the recorded data for various sensors. The table has four columns: 'Name', 'Min Value', 'Max Value', and 'Unit'. Each value in the 'Min Value' and 'Max Value' columns has a small 'x' icon next to it, indicating it can be edited. At the bottom right of the screen, there is a 'Save' button.

Name	Min Value	Max Value	Unit
Continuous Codes	2d	30.0	
Left Front Wheel Speed Sensor(km/h)	0.0	0.0	km/h
Left Rear Wheel Speed Sensor(km/h)	0.0	0.0	km/h
Right Front Wheel Speed Sensor(km/h)	0.0	0.0	km/h
Right Rear Wheel Speed Sensor(km/h)	0.0	0.0	km/h

You can change the Min or Max value, and tap "Save" to save it as a Data Stream Sample. All Data Stream Sample files are stored in "User Info -> Data Stream Sample".

- Compare Sample: Tap "Compare Sample" to select the saved Data Stream Sample files. The following page will appear:

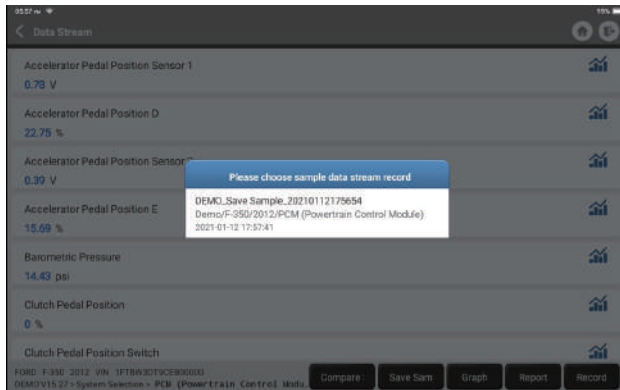

Tap the file you need. The following page will appear:

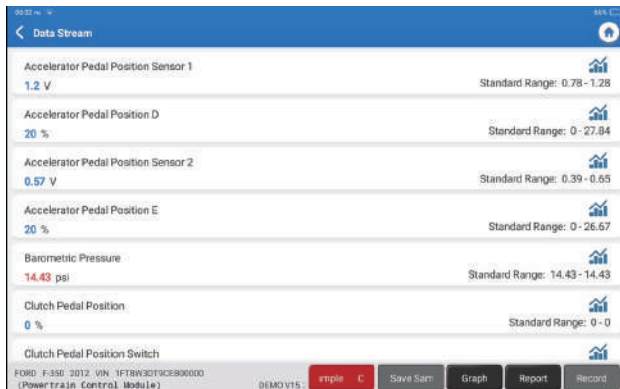

The Standard Range column will show the corresponding Data Stream Sample values for your comparison and analysis.

- Graph: To have the selected data streams (12 max items) displayed in waveform. Tap “Graph”. The following page will appear:



Tap “Combine” to merge graphs for easier comparisons (max 4 values can be merged).

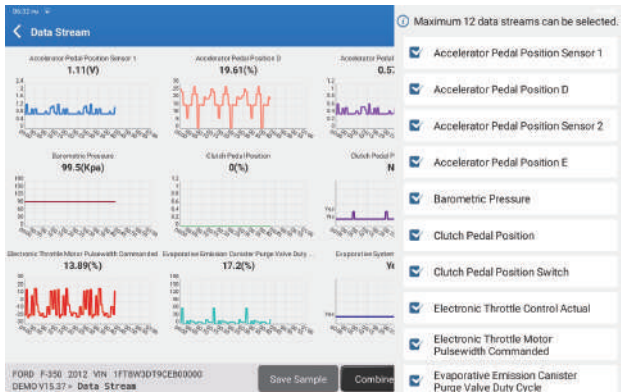

Tap “Value” to view the data displayed in values.

Tap “<” on the right side of the screen. The following page will appear:



You can select specific data stream options to be viewed on the left.

Note: A maximum of 12 data streams can be displayed in this module.

- Report: To save the number of current data streams.
- Record: To record the diagnostic data for further analysis.
-  : To view single data stream displayed in waveform. Tap "".
The following page will appear:

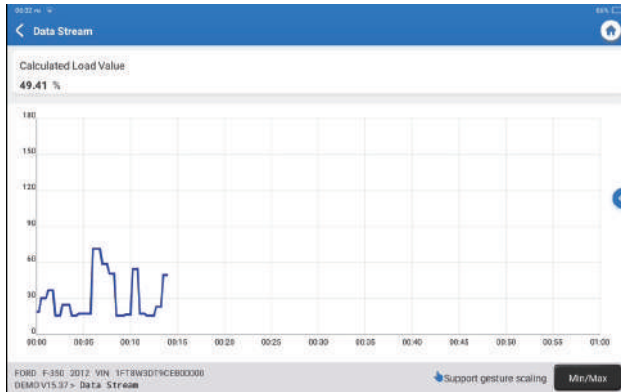

Tap "Min/Max" to define the maximum/minimum value. Once the value goes beyond the specified value, the data will be shown in red.

Tap "<" on the right side of the screen. The following page will appear:

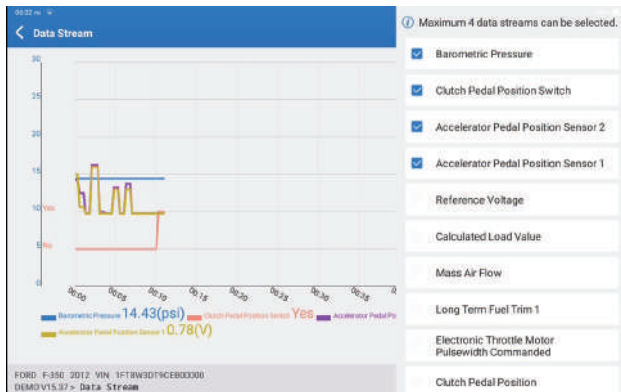

You can select specific data stream options to be viewed on the left.
Note: A maximum of 4 data streams can be displayed in this module.

E. Actuation Test

This function is used to find out whether a specific subsystem or component in vehicles goes well or not, by testing output elements instead of checking in ignition status.

F. Special function

This function is used for data writing operation of electronic control unit. They all belong to this category, such as ECU data calibration, ECU Programming etc. Some Resetting functions are also included in this part.

3. Services

TOPDON Phoenix Lite 2 is equipped with maintenance services to be very beneficial for technicians and mechanics working in the automotive repair industry.

3.1 OIL (Maintenance Light Reset)

This function enables you to reset the oil service lamp for the engine oil life system, which calculates an optimal oil life change interval depending on the vehicle driving conditions and weather events.

It needs to be performed in the following cases:

- If the service lamp is on, run car diagnostics first for troubleshooting. After that, reset the driving mileage or driving time, so as to turn off the service lamp, and enable a new driving cycle.
- If you have changed the engine oil or electric appliances that monitor oil life, you need to reset the service lamp.

3.2 ETS (Throttle Matching)

This function can utilize the car decoder to initialize the throttle actuator so that the learning value of the ECU returns to the initial state. By doing so, the movement of the throttle (or idle motor) can be more accurately controlled, thus adjusting the intake volume.

It needs to be performed in the following cases:

- After replacing the electronic control unit, the relevant characteristics of the throttle operation have not been stored in the electronic control unit.
- After the electric control unit is powered off, the memory of the electric control unit is lost.
- After replacing the throttle assembly, you need to match the throttle.
- After replacing or disassembling the intake port, the controlling of the idle speed by the coordination between the electronic control unit and the throttle body is affected.
- The intake volume and the idle control behavior has changed while staying at the same throttle opening position, although the idle throttle potentiometer behavior hasn't changed.

3.3 SAS (Steering Angle Reset)

This function can reset the steering angle to zero to keep the car running straight. It needs to be performed generally after replacing the steering angle position sensor, or after replacing the mechanical parts of the steering system (such as steering gear, steering column, tie rod ball head, steering knuckle), or after completing the four-wheel positioning, body repair, etc.

3.4 BMS (Battery Matching)

This function can reset the monitoring unit of the car battery, by clearing the original breakdown information about the lack of battery power to rematch the battery.

It needs to be performed in the following cases:

- Replacement of the main battery needs to utilize battery matching to clear the former information about the lack of power, thus avoiding false information detected by the relevant control module which may cause the failure of some electronic auxiliary functions. For example, the vehicle automatically stops; the sunroof can't work by one key; electric windows can't open and close automatically.
- The battery monitoring sensor uses the battery matching function to re-match the control module with the monitoring sensor, so as to detect the use of the battery power more accurately, and avoid receiving wrong information from instrument prompts which will cause false alarms.

3.5 BLEEDING (ABS Bleeding)

This function enables you to perform tests to check the operating conditions of the Anti-lock Braking System (ABS).

It needs to be performed in the following cases:

- When the ABS lines contain air.
- When the ABS computer, ABS pump, brake master cylinder, brake cylinder, brake line, or brake fluid is replaced.

3.6 BRAKE (Electronic Parking Brake Reset)

This function helps you to replace and reset the brake pads.

It needs to be performed in the following cases:

- The brake pads and brake pad wear sensor are replaced.
- The brake pads indicator lamp is on.
- The brake pads sensor circuit is short, which is recovered.
- The servo motor is replaced.

3.7 DPF (DPF Regeneration)

This function can help remove particulate matter from the trap by using combustion oxidation methods to keep the performance of the trap stable.

It needs to be performed in the following cases:

- Replace the exhaust back pressure sensor.
- Disassembly or replacement of the particle trap.
- Removal or replacement of fuel additive nozzles.
- Removal or replacement of catalytic oxidizer.
- The DPF regeneration fault lamp is lit and matched after maintenance.
- Repair and replace the DPF regeneration control module.

3.8 GEAR (Tooth Learning)

This function can perform tooth learning for the car, to turn off the MIL

It needs to be performed in the following cases:

- After the engine ECU, crankshaft position sensor, or crankshaft flywheel is replaced.
- The DTC "tooth not learned" is present.

3.9 IMMO (Anti-theft Matching)

This function can match the anti-theft key after replacing the ignition key, ignition switch, instrument cluster, engine control unit (ECU), body control module (BCM), and remote control battery.

3.10 INJEC (Injector Coding)

This function can write injector actual code or rewrite code in the ECU to the injector code of the corresponding cylinder, so as to have more accurately control or correct cylinder injection quantity.

It needs to be performed in the following cases:

- After the ECU or injector is replaced.

3.11 TPMS (Tire Pressure Reset)

This function can reset the tire pressure and turn off the tire pressure fault indicator when the car tire pressure fault indicator light is on.

3.12 SUS (Suspension Level Calibration)

This function can adjust the vehicle body height sensor for level calibration after replacing the vehicle height sensor or control module in the air suspension system, or when the vehicle level is not correct.

3.13 AFS (Adaptive Front-lighting System Reset)

This function enables you to initialize the adaptive headlamp system.

3.14 GEAR BOX (A/T Learning)

This function helps complete the gearbox self-learning to improve gear shifting quality.

It needs to be performed in the following cases:

- When the gearbox is disassembled or repaired (after some of the car battery is powered off), which leads to shift delay or impact problem.

3.15 SUN (Sunroof Initialization)

This function enables you to set the sunroof lock off, or closed when it rains; the sliding / tilting sunroof memory function; the temperature threshold outside the car etc.

3.16 EGR (EGR Adaption)

This function can learn the EGR (Exhaust Gas Recirculation) valve after it is cleaned or replaced.

3.17 ODO (ODO Reset)

This function can copy, write, or the value of kilometers in the chip of odometer, so that the odometer shows the actual mileage.

It needs to be performed in the following cases:

- When the mileage is not correct due to the damaged vehicle speed sensor or the odometer failure.

3.18 AIR BAG (Airbag Reset)

This function resets the airbag data to clear the airbag collision fault indicator, so that the airbag computer in the vehicle can run normally.

It needs to be performed in the following cases:

- When the vehicle collides and the airbag deploys, the corresponding fault code of the collision data appears, the airbag indicator lights up, and the fault code cannot be cleared.

3.19 TRANSPORT (Transport Mode)

This function can deactivate the transport mode, so that the vehicle can function normally.

It needs to be performed in the following cases:

- When the following functions disabled including limiting the vehicle speed, not waking up the door opening network, and disabling the remote control key, etc. in order to reduce the power consumption.

3.20 A/F (A/F Reset)

This function can set or learn Air/Fuel ratio parameters.

3.21 STOP/START (Stop/Start Reset)

This function can open or close the automatic start-stop function via setting the hidden function in ECU (provided that the vehicle has a corresponding hidden function supported by hardware).

3.22 NOX (NOx Sensor Reset)

This function can reset the catalytic converter learned value stored in the engine ECU. It needs to be performed in the following cases:

- When the NOx fault is re-initialized and the NOx catalytic converter is replaced.

3.23 ADBLUE (Diesel Engine Exhaust Gas Filter)

After the diesel exhaust treatment fluid (car urea) is replaced or filled up, urea reset operation is required.

3.24 SEATS (Seat Calibration)

This function can match the seats with memory function that are replaced and repaired.

3.25 COOLANT (Coolant Bleeding)

This function can activate the electronic water pump before venting the cooling system.

3.26 TYPE (Tire Reset)

This function can set the size parameters of the modified or replaced tire.

3.27 WINDOWS (Windows Calibration)

This feature can perform door window matching to recover ECU initial memory, and recover the automatic ascending and descending function of power window.

3.28 LANGUAGE (Language Change)

This function can change the system language of the vehicle central control panel.

4. Tester

Use with the battery detection module, it can detect the battery performance and determine whether the battery needs to be replaced. Regarding the use of the battery detection module, you can tap the "Use Guide" in the interface below to view.



Notes: TESTER function requires additional hardware (optional), which needs to be purchased.

5. Support

In this function, you can request remote assistance through third-party software [teamview]. By sending your device ID number to the remote technician or after-sales personnel, you can authorize the other party to remotely operate the Phoenix Lite 2 device, so as to guide you to the problems encountered in the process of using the device.

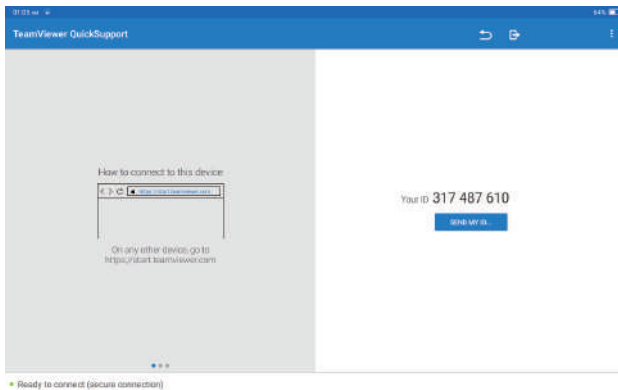

6. Update

This module allows you to update the diagnostic software & App to the latest version. Tap "Update" on the Home Menu. The following page will appear:

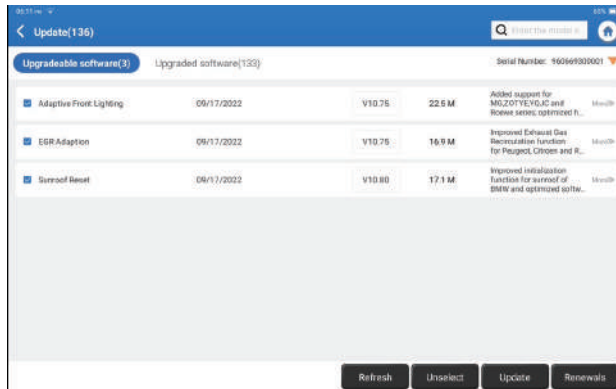

Tap "Update" to upgrade the selected software.

7. Library

Tap "Library" on the Home Menu. The following page will appear:

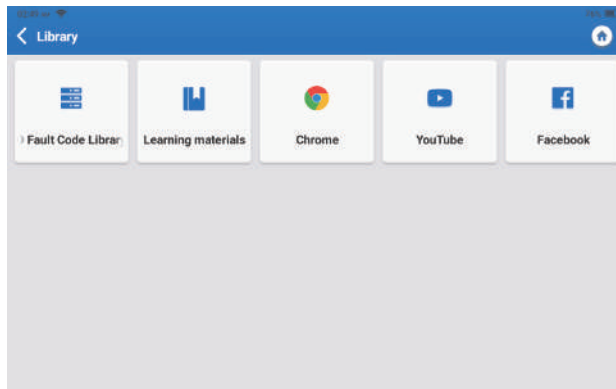

7.1 OBD Fault Code Library: To view the definition of DTCs (Diagnostic Trouble Codes).

7.3 Learning Materials: To view the playback of operating functions on specific vehicle models.

7.4 Chrome: chrome browser.

8. History

This module can record and establish the file of the diagnosed vehicles, including all diagnostic-related data such as diagnostic reports, data stream records, and screenshots.

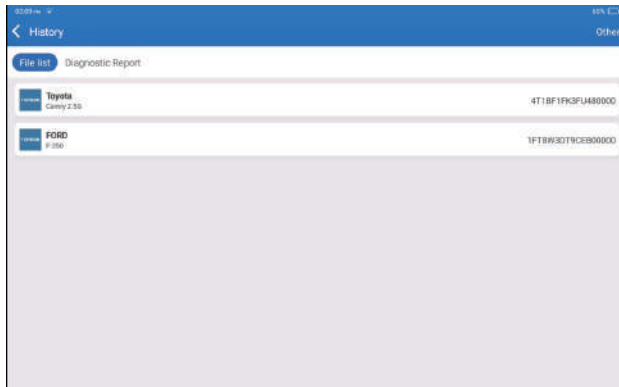

9. Feedback

You can send the last 20 test records to us by using "Feedback" feature for timely technical assistance if you encounter any unsolved problems in the diagnostic process.

Tap "Feedback" on the Home Menu. The following page will appear:

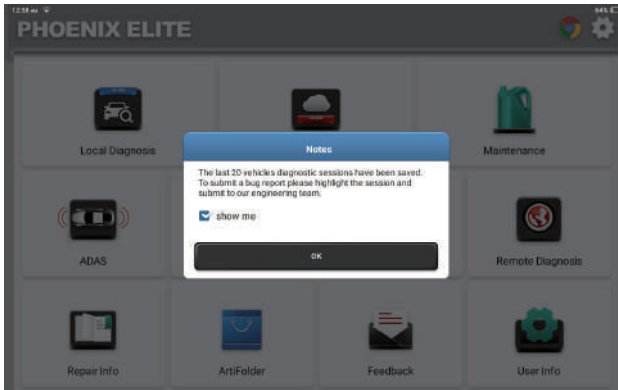

Tap “OK” to enter the vehicle diagnostic feedback selection menu.

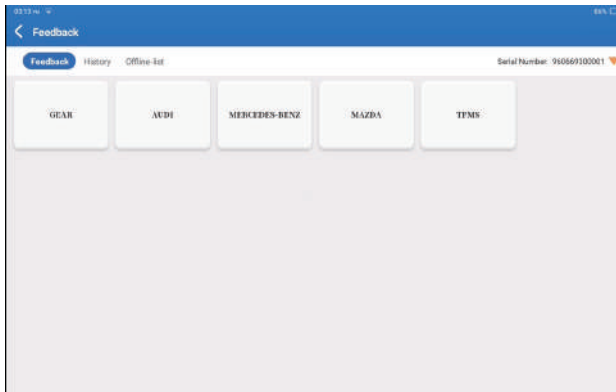

*Explanation of terms:

- Diagnostic Feedback: To show the tested vehicle model list.
- History: To view all diagnostic feedback and check the processes.
- Offline List: To display all diagnostic feedback logs which have not been submitted successfully yet due to the network failure. The failed logs will be re-uploaded automatically once the tablet gets the stable network signal.

Our technical support will handle your feedback in time for your satisfaction.

10. Coverage List

To view the supported functions and car systems after selecting the vehicle make, model, year, and inputting information required on the following page:

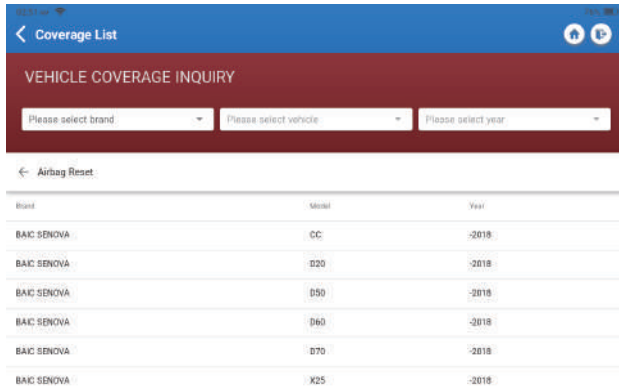

The screenshot shows the 'Coverage List' app interface. At the top, there is a blue header with a back arrow, the text 'Coverage List', and a user profile icon. Below the header is a dark red banner with the text 'VEHICLE COVERAGE INQUIRY'. Underneath the banner are three dropdown menus: 'Please select brand', 'Please select vehicle', and 'Please select year'. Below the dropdowns is a section titled 'Airbag Reset' with a back arrow. Underneath is a table with three columns: 'Brand', 'Model', and 'Year'. The table contains six rows of data for BAC SENNOVA vehicles.

Brand	Model	Year
BAC SENNOVA	CC	-2018
BAC SENNOVA	D20	-2018
BAC SENNOVA	D50	-2018
BAC SENNOVA	D60	-2018
BAC SENNOVA	D70	-2018
BAC SENNOVA	X25	-2018

11. User Info

You can modify or add related information in this module, or make settings.

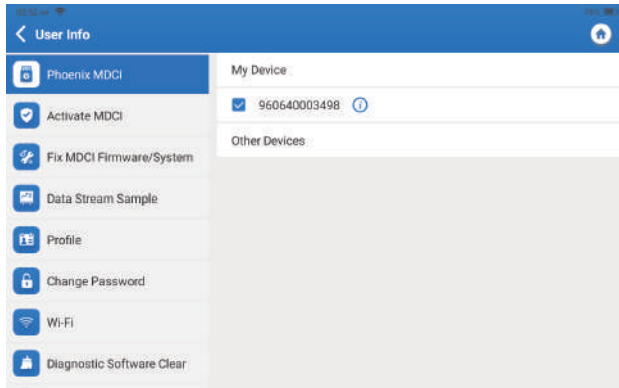

The screenshot shows the 'User Info' app interface. At the top, there is a blue header with a back arrow, the text 'User Info', and a user profile icon. Below the header is a list of settings: 'Phoenix MDCI', 'Activate MDCI', 'Fix MDCI Firmware/System', 'Data Stream Sample', 'Profile', 'Change Password', 'Wi-Fi', and 'Diagnostic Software Clear'. To the right of the settings is a 'My Device' section with a device ID '960640003498' and a 'Other Devices' section which is currently empty.

11.1 Phoenix MDCI

This option allows you to choose the suitable MDCI dongle if there are several dongles registered on this tablet.

11.2 Activate MDCI

This option can activate a new MDCI dongle.

Input the Serial Number and Activation Code, and then tap “Activate” to activate the MDCI dongle. Its serial number will be displayed in the list after the procedure.

11.3 Fix Connector Firmware/System

This option can repair the connector firmware. Please don't power off or switch interfaces in the process.

11.4 Data Stream Sample

This option manages the recorded data stream sample files.

11.5 Profile

To set and manage personal information.

11.6 Change Password

This option can change the login password.

11.7 Wi-Fi

This option sets up Wi-Fi networks that can be connected.

11.8 Diagnostic Software Clear

This option can clear some cache files and free up the storage space.

11.9 Business Information

This option can add information about the workshop, which will be displayed in the diagnostic report.

11.10 Customer Management

This option manages the information and data of clients.

11.11 Photo Album

This module saves the screenshots.

11.12 Screen Recorder

This module saves the screen recordings.

11.13 Settings

This option makes settings including Units, Language, Clear Cache, USB Connection Mode, Restore Factory Settings, and Log Out.

Technical Specification

Operating System: Android 10.0

Screen: 8" Touchable; 1280 * 800

Memory: 2G

Storage: 32G

Battery Capacity: 12,600mAh/3.7V

Camera: Rear 8.0MP

Network: Wi-Fi, WLAN 802.11b/g/n

Bluetooth: Bluetooth 5.0

Working Temperature: 32°F~122°F (0°C~50°C)

Storage Temperature: -14°F~140°F (10°C~60°C)

Dimension: 10.16*7.2*1.98inches (258mm*183mm*50.3mm)

Weight: 42.08 oz (1192g)

Warnings

- ✔ Always perform automotive testing in a safe environment.
- ✔ DO NOT smoke near the vehicle during testing.
- ✔ DO NOT place the diagnostic tool near the engine or exhaust pipe to avoid damage from high temperatures.
- ✔ DO NOT wear loose clothing or jewelry when working on an engine.
- ✔ DO NOT connect or disconnect any test equipment while the ignition is on or the engine is running.
- ✔ DO NOT disassemble the code reader.
- ✔ Engine parts will become hot when the engine is running. To prevent severe burns, avoid contact with hot engine parts.
- ✔ When an engine is running, it produces carbon monoxide, a toxic and poisonous gas. Operate the vehicle ONLY in a well-ventilated area.
- ✔ Wear safety eye protection that meets ANSI standards.

Cautions

- ✔ Please ensure that the vehicle battery is fully charged and the scanner is firmly connected to the vehicle DLC to avoid erroneous data generated by the scanner and diagnostic systems.
- ✔ Please do not use the diagnostic tool during driving.
- ✔ Keep clothing, hair, hands, tools, test equipment, etc. away from all moving or hot engine parts.
- ✔ Keep the scanner dry, clean, free from oil/water, or grease. Use a mild detergent on a clean cloth to clean the outside of the scan tool, when necessary.
- ✔ Keep the scanner out of the reach of children.

FAQ

Q: The tablet cannot be turned on after being fully charged.

A:

Possible Cause	Solution
The tablet has been standby for too long, and the battery drains.	Charge it for over 2 hours before turning it on.
Problem of the Charger.	Please contact the dealer or TOPDON after-sale service for timely support.

Q: Why cannot register?

A:

Possible Cause	Solution
The tablet isn't connected to a network.	Make sure the network is stable.
Your email address may have been registered already.	Use another valid email address.
There is no verification code in the email box.	Check if the email address is valid and resent the code.
Server problem.	Server maintenance. Please try again later.

Q: Why cannot login?

A:

Possible Cause	Solution
The tablet isn't connected to a network.	Make sure the network is stable.
The user name or password is not correct.	<ul style="list-style-type: none">• Check the user name and password.• Contact TOPDON after-sales support to get the user name and password.
Server problem.	Server maintenance. Please try again later.

Q: Why can't activate the equipment?

A:

Possible Cause	Solution
The tablet isn't connected to a network.	Make sure the network is stable.
The serial number and activation code are not correct.	Check the serial number and activation code and make sure they are correct (serial number 12 digits, activation code 8 digits).
The activation code is invalid.	Contact TOPDON after-sales service to get support.
The configuration is empty.	Contact TOPDON after-sales service to get support.

Q: The tablet is not activated while updating?

A:

Possible Cause	Solution
The MDCI dongle may not be activated in the registration process.	Activate the MDCI dongle as follows: Tap "User Infor" -> "Activate MDCI" -> Input the correct serial number and activation code -> "Activate".

Q: There is no power in the MDCI dongle after connecting to the vehicle's DLC port.

A:

Possible Cause	Solution
Poor contact of the MDCI dongle.	Plug out the MDCI dongle, and then plug it in again.
Poor contact of vehicle's DLC port.	Plug out the MDCI dongle, and then plug it in again.
Too low voltage of the vehicle battery.	<ul style="list-style-type: none">• Recharge the vehicle battery.• Replace the vehicle battery if it is damaged.
Fuse blown.	Check the fuse of the OBD module.

Q: The tablet cannot establish a connection with the MDCI dongle.

A:

Possible Cause	Solution
Poor contact of the MDCI dongle.	<ul style="list-style-type: none">• Plug out the MDCI dongle, and then plug it in again.• Perform the MDCI Bluetooth pairing again.
The firmware is damaged.	Enter the settings and tap "Fix Connector Firmware/System" to fix the firmware.

Q: Can I use other chargers to charge the tablet?

A: No, please use the original charger provided by TOPDON.

Any damage and economic loss caused by using the improper battery charger will not be our responsibility.

Q: How to save the battery power?

A: Please switch off the screen while the tablet is idle, or set a short standby time, or reduce the brightness of the screen.

Q: Are there non-standard OBDII adapters in the box?

A: Yes.

Q: Communication error with vehicle ECU?

A: Please confirm the following cases:

- Whether the diagnostic MDCI dongle is correctly connected.
- Whether the ignition switch is ON.

Or, send your vehicle's year, make, model, and VIN data to us via the "Feedback" feature for timely technical assistance.

Q: Failed to get access to the vehicle's ECU system?

A: Please confirm the following cases:

- Whether the system is available in the vehicle.
- Whether the MDCI dongle is correctly connected.
- Whether the ignition switch is ON.

Q: The MDCI dongle is missing.

A: Please contact the dealer or TOPDON after-sale service for timely support.

Q: Error of the diagnostic software.

A: Please operate as follows:

- Tap "Feedback" to send specific problems to us for technical support.
- Tap the vehicle software icon, and hold it to uninstall the corresponding software, and then enter the upgrade center to download and install the new version.

Q: The downloaded diagnostic software is inconsistent with the serial number.

A: Selected the wrong MDCI dongle.

Enter the "User Info" -> "MDCI" -> select the right MDCI dongle.

FCC Statement:

This device complies with Part 15 of the FCC Rules. Operation is subject to the following two conditions:

- 1) This device may not cause harmful interference, and 2) This device must accept any interference received, including interference that may cause undesired operation.